

Dear R. L. H. Essery,

Thank you very much for your detailed comments which helped to clarify the manuscript. We have been through them in detail and made amends as requested. We provide a point to point response below to your comments (AC), as well as changes in the manuscript (CM). We also provide a revised manuscript in “tracked changes mode”. Please note that page numbers refer to the page numbers in the revised manuscript.

On behalf of the authors,

Julia Boike

A 16-year record (2002–2017) of permafrost, active layer, and meteorological conditions at the Samoylov Island Arctic permafrost research site, Lena River Delta, northern Siberia: an opportunity to validate remote sensing data and land surface, snow, and permafrost models

by Julia Boike et al.

R. L. H. Essery (Referee)

Received and published: 22 August 2018

RC: Referee comment | **AC:** Author comment | **CM:** Change in the manuscript

RC1.01: This is a very valuable dataset, considering the lack of well-maintained and quality controlled long-term records in the Arctic, but it does not quite live up to the claim of utility for validation of land surface models. Gaps in validation data are not a problem, but such models cannot handle gaps in their driving data. I entirely understand why measurements of solid precipitation are difficult, but the entire lack of such measurements in particular is fatal. The Level 2 meteorological dataset available from PANGAEA combines data from multiple sensors, but gaps are not filled and physically impossible values have not been replaced. If a fully gap filled and despiked Level 3 meteorological dataset is beyond the scope of this paper, the potential uses of the data would be greatly expanded if the corrected reanalysis data used by Chadburn et al. (2017) could also be included in the archive.

AC1.01: Several points are raised which we would like to address the following:

(1) Solid precipitation measurements

As we did not have continuous power sources until summer 2015, as well as no permanent research base during the fall-winter-spring periods, our instrumentation depended on low energy consumption and non-supervision during these periods. Because of the extreme weather conditions during winter, we often had sensor loss and data gaps. Solid precipitation measurements, for example, heated precipitation gauges, require high power supply as well as supervision. We are currently planning the installation of a heated precipitation gauge for measuring solid (total) precipitation during winter.

(2) Gap filling, replacement of physically impossible values

The aim of this paper was to publish the observational data; any gap-filling will require either additional (non-site specific) data sources or interpolation/extrapolation of the observed values. Either way data will be inserted that is not 'real', and there are choices to make about how to do this, which we would leave in the hands of the data user, depending on the purpose for which they want to use it.

We apply a strict quality analysis which also includes a flagging for "physically impossible values". These data are marked in the dataset using the Flag 4 (physical limits: values outside the physically possible or likely limits) which is discussed in the paper (line 560).

(3) Corrected reanalysis data by Chadburn et al. (2017)

Based on this comment, we have now archived the gap filled and quality controlled driving data for the Chadburn et al. 2017 paper in PANGAEA (Burke et al., 2018). This data set includes all driving data of the PAGE21 sites that have been used and updated for the Chadburn et al. (2017) publication, including the Samoylov site. Eleanor Burke has now been included as a co-author in this ESSD publication since she contributed largely to this driving data dataset.

As described in the paper and on the PANGAEA webpage: These meteorological driving data were prepared using observations from the sites combined with reanalysis data for the grid cell containing the site. For the period 1901–1979, Water and Global Change forcing data (WFD) were used (Weedon et al., 2011). This has half-degree resolution for the whole globe at 3-hourly time resolution from 1901 to 2001. For the period 1979–2014, WATCH-Forcing-Data-ERA-Interim (WFDEI) was used (Weedon, 2013). For the time periods in which observed data were available, correction factors were generated by calculating monthly biases relative to the WFDEI data. These corrections were then applied to the time series from 1979 to 2014 of the WFDEI data. The WFD before 1979 were then corrected to match these data and the two datasets were joined at 1979 to provide gap-free 3-hourly forcing from 1901 to 2014. Local meteorological station observations were used for all variables except snowfall, which was estimated from the observed snow depth by treating increases in snow depth as snowfall events with an assumed snow density. See Chadburn et al. (2017) for more details.

CM1.01: Line 184: The gap-free meteorological dataset that was produced and used in Chadburn et al. (2017) is now available on the PANGAEA database (Burke et al., 2018), making it easy for modellers to begin running the Samoylov site and therefore to make good use of our data.

RC1.02: line 32: Snow could also be mentioned as being involved in positive feedbacks and links to energy balance.

AC1.02: We agree that snow is a very important component of the cryospheric feed backs and added this in the abstract as suggested.

CM1.02: Line 37: Permafrost thaw and carbon release into the atmosphere, as well as snow cover changes, are positive feedback mechanisms that have the potential for climate warming.

RC1.03: line 38: It took me a long time to understand why datasets in this paper start in 2002 if observations began in 1998; I think it is because data from 1998 onwards have already been documented in Boike et al. (2013).

AC1.03: For clarification, we added a sentence following the sentence above.

CM1.03: Line 45: Furthermore, we present a merged dataset of the parameters, which were measured from 1998 onwards.

RC1.04: line 50: I would use the English word “level” in place of “niveau”.

AC1.04: We adopted this suggestion.

CM1.04: The depth of zero annual amplitude is at 20.75 m. At this depth, the temperature has increased from -9.1 °C in 2006 to -7.7 °C in 2017.

RC1.05: line 103: “starts at the end of May”

AC1.05: We adopted this suggestion.

CM1.05: The active layer thawing period starts at the end of May and active layer thickness reaches maximum at the end of August/beginning of September.

RC1.06: line 116: Is the intended meaning here “at a few” or “at only a few”? The emphases is different.

AC1.06: We adopted this suggestion.

CM1.06: Line 129: Degradation of ice wedges, as observed throughout the Arctic (Liljedahl et al., 2016), occurs at only a few, localized parts of the research site (Kutzbach, 2006). The recent work by Nitzbon et al. (2018) shows that the spatial variability in the types of ice-wedge polygons observed at this study area can be linked to the spatial variability in the hydrological conditions. Furthermore, wetter hydrological conditions have a destabilizing effect on ice wedges and enhance degradation.

RC1.07: line 119: Replace “thereof” with “of which”

AC1.07: We adopted the suggestion proposed by the referee.

CM1.07: The total mapped area of the polygonal tundra on Samoylov Island (excluding the floodplain) is composed of 58% dry tundra, 17% wet tundra and 25% water surfaces, of which 10% are over-grown water and 15% open water (Muster et al., 2012, Figure 3a).

RC1.08: line 186: The air may have been stagnant, but I think that “constant air temperature values” is intended here.

AC1.08: We adopted the suggestion proposed by the referee.

CM1.08: During extreme cold air temperature periods, for example, between 1 February and 10 March 15, 2013, constant air temperature values were recorded at the sensor’s output limit.

RC1.09: line 219: Errors for snow-covered radiometers could be much more than 10%, but comparison of outgoing and incoming shortwave radiation gives some indication of when this has occurred (flag 8?).

AC1.09: We adopted this suggestion and did apply another quality analysis. We flagged radiation data during those time periods where short wave incoming radiation was lower than shortwave outgoing radiation by 10 Wm⁻² using Flag 6 (plausibility, values unlikely in comparison with other sensor series or for a given time of the year). Using this analysis, 111 out of 134 839 values (30 June 2009 to 21 July 2017), equalling less than 1% of radiation data were flagged during the winter period. Please note that this quality analysis does not differentiate if the sensors were covered by snow or dirt.

CM1.09: Line 247: Our quality analysis also includes flagging the data during those periods where short wave incoming was lower than shortwave outgoing by 10 Wm^{-2} using Flag 6 (plausibility, values unlikely in comparison with other sensor series or for a given time of the year). Between 30 June 2009 to 21 July 2017, less than 1% of the data were flagged.

RC1.10: line 239: Date for placement of the metal plate differs by a year between here and the caption of Figure B4. Why does the snow depth appear to be constant for a long period in 2017?

AC1.10: The reviewer is correct about the date discrepancy and we have corrected the figure legend B4. In 2017, crusted snow occurred on the top of the snow under the sensor and almost all fresh snow was blown away. This can be seen on the time lapse images of the snow surface that are also provided with the data (see section 3.1.6).

CM1.10: Figure B4. Campbell Scientific SR50 snow depth sensor, installed on 24 August 2002. An aluminum plate was installed on the ground surface beneath the sensor beam on 17 July 2015.

RC1.11: line 260: That is Figure 4 of Gouttevin et al., not here.

AC1.11: Adopted as suggested.

CM1.11: We have removed the reference to Figure 4 of Gouttevin et al. from the paper. The reference Gouttevin et al. 2018 has been updated in the reference section.

RC1.12: line 378: In the absence of calibration, why is a probe constant different from the recommendation chosen?

AC1.12: We custom ordered the Campbell Scientific CS605 TDR probes with a length of 20 cm instead of the regularly sold 30 cm. The probe constant is given only for the 30 cm probe in the CSI manual. Thus we entered the multiplier of "1" for later calibration of the probes.

CM1.12: Because no calibration was done, and the TDR probes were custom made to 20 cm, a probe constant (K_p) of 1 was used for BEC waveform retrieval;..

RC1.13: line 499: Incomplete sentence

AC1.13: Adopted as suggested.

CM1.13: This makes this an important dataset for modellers.

RC1.14: Figure 4 (which might instead be described as Table 4) misses a bar for 3.5 months of HMP155A.

AC1.14: As the Vaisala HMP155A was installed on 17 September 2017 and the dataset ends on 21 September 2017 the bar is very thin and hard to recognize.

CM1.14: Line 588: Figure 4: Note that the measuring period for the Vaisala HMP155A only started 17 September, 2017, which is why the bar appears very thin. Recording of all parameters is still continuing at present.

References

Burke, E. J., Chadburn, S., Krinner, G., Porada, P., Bartsch, A., Beer, C., Belelli Marchesini, L., Boike, J., Ekici, A., Elberling, B., Friborg, T., Hugelius, G., Johansson, M., Kuhry, P., Kutzbach, L., Langer, M., Lund, M., Parmentier, F.-J. W., Peng, S., van Huissteden, J. (K.), Wang, T., Westermann, S., and Zhu, D.: Meteorological forcing data to run land surface models for five high latitude sites. Derived from reanalysis products combined with site observations, PANGAEA, <https://doi.pangaea.de/10.1594/PANGAEA.896133> (DOI registration in progress), 2018.

Chadburn, S. E., Krinner, G., Porada, P., Bartsch, A., Beer, C., Belelli Marchesini, L., Boike, J., Ekici, A., Elberling, B., Friborg, T., Hugelius, G., Johansson, M., Kuhry, P., Kutzbach, L., Langer, M., Lund, M., Parmentier, F.-J. W., Peng, S., Van Huissteden, K., Wang, T., Westermann, S., Zhu, D., and Burke, E. J.: Carbon stocks and fluxes in the high latitudes: using site-level data to evaluate Earth system models, *Biogeosciences*, 14, 5143–5169, DOI:10.5194/bg-14-5143-2017, 2017.

Nitzbon, J., Langer, M., Westermann, S., Martin, L., Aas, K. S., and Boike, J.: Pathways of ice-wedge degradation in polygonal tundra under different hydrological conditions, *The Cryosphere Discussion*, DOI:10.5194/tc-2018-211, in review, 2018.

Weedon, G. P., Gomes, S., Viterbo, P., Shuttleworth, W. J., Blyth, E., Österle, H., Adam, J. C., Bellouin, N., Boucher, O., and Best, M.: Creation of the WATCH Forcing Data and Its Use to Assess Global and Regional Reference Crop Evaporation over Land during the Twentieth Century, *Journal of Hydrometeorology*, 12(5), 823–848, 2011.

Weedon, G. P.: Readme file for the "WFDEI" dataset, available at: http://store.pangaea.de/Publications/Chadburn-et-al_2018/README-WFDEI.pdf, 2013.

Dear N. Brown,

Thank you very much for your detailed comments which helped to clarify the manuscript. We have been through them in detail and made amends as requested. We provide a point to point response below to your comments (AC), as well as changes in the manuscript (CM). We also provide a revised manuscript in “tracked changes mode”.

On behalf of the authors,

Julia Boike

A 16-year record (2002–2017) of permafrost, active layer, and meteorological conditions at the Samoylov Island Arctic permafrost research site, Lena River Delta, northern Siberia: an opportunity to validate remote sensing data and land surface, snow, and permafrost models

by Julia Boike et al.

N. Brown (Referee)

Received and published: 08 November 2018

RC: Referee comment | **AC:** Author comment | **CM:** Change in the manuscript

RC2.01: (multiple locations): Dielectric number vs. dielectric constant vs. relative permittivity. I have most frequently seen the second of these used, although I understand it is falling out of fashion in favor of the third. This is the first time I have seen the term dielectric number used. I see that in appendix A you note the equivalence of these terms, but I think it would be useful to clarify this on the first mention of the term.

AC2.01: The dielectric constant, dielectric number or relative permittivity all have the same meaning. Dielectric constant was used in earlier times, but since it is not a “constant”, we prefer to use dielectric number.

CM2.01: The sensor outputs a single period measurement from which usually the bulk dielectric number is calculated. The dielectric number (also referred to as the relative permittivity or dielectric constant) is then used to calculate the volumetric water content using an empirical polynomial calibration provided by the manufacturer.

RC2.02: L233: After you checked the buckets by pouring in a known volume of water, was this spike removed from the dataset? Were there any instances where the instrument was found to be in error based on this check?

AC2.02: In general, we find that the rain gauges performed very well, even after long periods of non attendance. This could be due to very little vegetation, litter or terrestrial material collected in the rain gauge. The field calibration was done by pouring a known volume of water into the gauge and recording the tipping. We did not find any errors or deviations to

the original calibrations by the manufacturer. The calibration “spikes” were marked in the data set using Flag 3 (example July 16, 2012). Flag 3 (maintenance) is used for all calibration work that is done by the engineers and visible in the data.

CM2.02: Line 267: These calibration data are flagged with Flag 3 (maintenance periods).

RC2.03: L297: The month, or time of year, would be helpful to contextualize the thaw depth measurements

AC2.03: We adopted the suggestion proposed by the referee.

CM2.03: A new measurement station was established in August 2002, with instruments installed in four profiles (Appendices B2 and F).

RC2.04: L335: You mention that the errors are estimated based on the temperature values during zero-curtain periods. Can you be more specific about how exactly you derive the error estimates from these periods?

AC2.04: Because the temperature sensors were installed in the soil, and thus cannot be retrieved for recalibration or repair, we use the zero curtain effect to evaluate the accuracy of the probes. During the freeze back period, the soil temperature data are around 0 °C due to the phase change of water to ice. Basically, we use this zero curtain effect as ice bath calibration where the accuracy is tested against 0°C of ice slush water. During these phase change periods we obtained the maximum deviation to 0 °C to something up to ±0.7 °C for 2009.

CM2.04: Line 375: The zero curtain period during fall – winter, where temperatures in the ground are stabilized at 0°C during phase change, offers an accuracy test for sensors that cannot be retrieved.

RC2.05: L450: You introduce level 0, 1 and 2 data but only discuss levels 1 and 2 in the text. Please consider briefly discussing level 0 data as well (PANGAEA): Data are well organized on PANGAEA, but I notice that columns in the soil level 1 dataset are inconsistent between files which will throw off attempts to combine the yearly files. Although this can be solved relatively easily, such a hurdle may make the dataset less accessible to those with little programming experience. Standardizing the columns and simply having NA values in the years where the borehole data are not present would eliminate this problem.

AC2.05: We added NA values for the borehole in the years 2002-2005 to make the dataset consistent and more easily accessible. We also performed a second quality check of all data sets again. These revised data are now available on PANGAEA and Zenodo.

We also added information on Level 0 in the text as well as in Table 3.

CM2.05: Line 493: Level 0 are data with equal time steps (UTC), data gaps filled with NA and standardized into one file format. These data, as well as raw data, are stored internally at AWI and are not archived in PANGAEA.

Page 38, line 580: (Table 3): Standardized format with data in equal time steps (UTC), filled with NA for data gaps.

RC2.06: L49: “The depth of zero annual amplitude . . . has warmed”. Clarify here that it is the temperature at that depth which has warmed, not the depth itself

AC2.06: Adopted as suggested.

CM2.06: The depth of zero annual amplitude level is at 20.75 m. At this depth, the temperature has increased from -9.1 °C in 2006 to -7.7 °C in 2017.

RC2.07: L50: 'niveau' not needed here

AC2.07: We adopted the suggestion proposed by the referee.

CM2.07: The depth of zero annual amplitude ~~niveaus~~ is at 20.8 m, and has warmed from -9.1 °C in 2006 to -7.7 °C in 2017.

RC2.08: L68: "land surface o for" typo

AC2.08: We adopted the suggestion proposed by the referee.

CM2.08: The seasonal snow cover in Arctic permafrost regions can blanket the land surface ~~o~~ for many months of the year and has an important effect on the thermal regime of permafrost-affected soils (Langer et al., 2013).

RC2.09: L103 "thawing period starts the end of may". Should read: starts at

AC2.09: We adopted the suggestion proposed by the referee.

CM2.09: The active layer thawing period starts at the end of May and active layer thickness reaches maximum at the end of August/beginning of September.

RC2.10: L104 "reaches maximum at". Should read: reaches a maximum at

AC2.10: We adopted the suggestion proposed by the referee.

CM2.10: The active layer thawing period starts at the end of May and active layer thickness reaches a maximum at the end of August/beginning of September.

RC2.11: L186: "stagnant". Doesn't seem like the right word choice. Perhaps constant?

AC2.11: We adopted the suggestion proposed by the referee.

CM2.11: During extreme cold air temperature periods, e.g., between 1 February and 15 March 2013, ~~stagnant~~constant air temperature values were recorded at the sensor's output limit.

RC2.12: L192:"in parallel with". This is more an opinion, but consider using "alongside" to eliminate any possibility that the reader interprets this as the circuitry meaning of 'in paralell'.

AC2.12: We adopted the suggestion proposed by the referee.

CM2.12: Campbell Scientific PT100 temperature sensors were installed on 22 August 2013 ~~in parallel~~alongside the temperature and humidity probes, at the same heights but in separate unventilated shields, in order to circumvent this problem.

RC2.13: L205: 'aligned towards geographic north'. I see in the documentation for the instrument that this refers to the calibration with respect to azimuth. It is a bit confusing in the text as it suggests that the instrument is always pointing north.

AC2.13: Corrected as suggested.

CM2.13: This was done by orienting the center line of the sensor towards true north (using a GPS reference point) and then rotating the sensor base until the datalogger indicated zero degrees.

RC2.14: L288: "For the unfrozen. . .". The clarity of this sentence could be improved

AC2.14: For the unfrozen periods, the soil as measured by a dielectric device is a mixture of air, water, and soil particles.

CM2.14: For the unfrozen periods, the soil as measured by a dielectric device is a mixture of air, water, and soil particles.

RC2.15: L285,287: “signal period” vs “single period” are these meant to be different terms?
AC2.15: We corrected the typo, the correct wording is “signal period”.

CM2.15: The sensor outputs a signal period measurement from which usually the bulk dielectric number is calculated.

RC2.16: L698,700, 712: Significant figures on regression equations – is this level of precision appropriate?

AC2.16: Note that the high precision of the fitting parameters is required, since the WL (in cm) estimated by equations (D1) and (D2) is very sensitive to these parameters.

CM2.16: No changes in the text.

RC2.17: L291: Consider “Instrument installation at the soil station”

AC2.17: We adopted the suggestion proposed by the referee.

CM2.17: 3.2.1 Instrument installation ~~of~~at the soil station and soil sampling

RC2.18: L296: Should this subheading have a numerical prefix? 3.2.2?

AC2.18: This subheading is hierarchically under the 3.2.1 heading. As ESSD does not want fourth level headings, this heading has not a numerical prefix.

CM2.18: No change in the manuscript.

RC2.19: L306: “Unfrozen topsoil layer” = thaw depth

AC2.19: Adopted as suggested.

CM2.19: The thaw depth was between 17 and 40 cm thick at the time of instrument installation.

RC2.20: L310: “Was probed at least once”. Would be clearer to say “contained at least one probe”

AC2.20: We adopted the suggestion proposed by the referee.

CM2.20: The sensors were positioned according to the soil horizons so that every horizon in the profile ~~was probed at least once~~contained at least one probe.

RC2.21: L376: “and the signal stabilized”. Missing word: signal has stabilized (stylistic)

AC2.21: We adopted the suggestion proposed by the referee.

CM2.21: The impedance can be determined from the attenuation of the electromagnetic wave traveling along the TDR probe after all multiple reflections have ceased and the signal has stabilized.

RC2.22: L388: “grounding system improved”. Missing word: system was improved (stylistic)

AC2.22: We adopted the suggestion proposed by the referee.

CM2.22: Data quality improved significantly after August 2015 when the Campbell Scientific coaxial SDMX50 multiplexers were exchanged for SDM8X50 and the electrical grounding system was improved.

RC2.23: L446: “located on Spitzbergen permafrost” should be “located on Spitzbergen”

AC2.23: Adopted as suggested.

CM2.23: located on Spitzbergen ~~permafrost~~

RC2.24: L449: “outliers manually” outliers have been manually (stylistic)

AC2.24: We adopted the suggestion proposed by the referee.

CM2.24: In addition to the automated processing, all data have been visually controlled and outliers have been manually detected, but it cannot be excluded that there are still unreasonable values present which are not flagged accordingly.

RC2.25: L449: “excluded” Doesn’t seem like the right word choice, consider ‘ruled out’

AC2.25: We adopted the suggestion proposed by the referee.

CM2.25: In addition to the automated processing, all data have been visually controlled and outliers have been manually detected, but it cannot be ~~excluded~~ ruled out that there are still unreasonable values present which are not flagged accordingly.

RC2.26: L457: “combined with data set” should be “combined with a data set”

AC2.26: We adopted the suggestion proposed by the referee.

CM2.26: Examples in this paper of Level 2 data are soil temperature and meteorological data (air temperature, humidity, wind speed, and net radiation) recorded between 1998–2002 (Boike et al., 2013) that have been combined with a data set since 2002 into a single data series, in order to obtain a long term picture (documentation of source data is provided in the PANGAEA data archives).

RC2.27: L467: “flagged in the dataset (Table 3: Flag 7)”

AC2.27: We adopted the suggestion proposed by the referee.

CM2.27: Our temperature data have been checked against the fall zero-curtain effect and information on any reduction in accuracy is ~~provided in Table 3~~ flagged in the data set (Flag 7: decreased accuracy; Table 3).

RC2.28: L471: “differences between the locations”. Clarify to “the sensor locations”

AC2.28: We adopted the suggestion proposed by the referee.

CM2.28: The local differences between the sensor locations from 1998 and 2002 (even though less than 50 m meters apart), as well as differences between sensor types and accuracies, need to be considered when interpreting longer term records.

RC2.29: L474: be consistent with the use of ‘record’ vs ‘data set’ (stylistic)

AC2.29: We adopted the suggestion proposed by the referee.

CM2.29: E.g., relative air humidity data show marked differences between the earlier ~~record~~ data set (1998–1999) compared to the later data set (starting in 2002).

RC2.30: L487: depth of 20.8m.

AC2.30: We adopted the suggestion proposed by the referee. We also changed the depth of 20.8 to 20.75 m (as in Pangea) since this is the exact installation depth.

CM2.30: Since the installation in 2006, permafrost has warmed by 1.3 °C at the zero annual amplitude ~~niveau~~ depth at 20.75 m ~~depth~~.

RC2.31: L499: incomplete sentence: “this makes this an important”

AC2.31: Adopted as suggested.

CM2.31: This makes this an important dataset for modellers.

**A 16-year record (2002–2017) of permafrost, active layer,
and meteorological conditions at the Samoylov Island
Arctic permafrost research site, Lena River Delta, northern
Siberia: an opportunity to validate remote sensing data and
land surface, snow, and permafrost models**

Julia Boike^{1,2}, Jan Nitzbon^{1,2,3}, Katharina Anders⁴, Mikhail Grigoriev^{5,6}, Dmitry ~~Bolshiyanev~~⁶[Bolshiyanev](#)⁷, Moritz Langer^{1,2}, Stephan Lange¹, Niko Bornemann¹, Anne Morgenstern¹, Peter Schreiber¹, Christian ~~Wille~~⁷[Wille](#)⁸, Sarah ~~Chadburn~~⁸[Chadburn](#)^{9,9,10}, Isabelle Gouttevin¹⁰, [Eleanor Burke](#)¹² and Lars Kutzbach^{13,14}

¹ Alfred Wegener Institute Helmholtz Center for Polar and Marine Research, Telegrafenberg A45, 14473 Potsdam, Germany

² Humboldt–Universität zu [Berlin](#), Geography Department, Unter den Linden 6, 10099 Berlin, Germany

³ University of Oslo, Department of Geosciences, Sem Sælands vei 1, 0316 Oslo, Norway

⁴ Heidelberg University, Department of Geography, ~~3D Geospatial Data Processing Research Group~~, Im Neuenheimer Feld 368, 69120 Heidelberg

⁵ Melnikov Permafrost Institute, Siberian Branch, Russian Academy of Sciences, Merzlotnaya St., 36, Yakutsk 677010, Russia

⁶ [Trofimuk Institute of Petroleum Geology and Geophysics Siberian Branch, Russian Academy of Science, Koptyug St., 3, Novosibirsk, 630090, Russia](#)

⁶⁻⁷ Arctic and Antarctic Research Institute, 38 Beringa Str., St. Petersburg, 199397, Russia

⁷⁻⁸ GFZ German Research Centre for Geosciences, Telegrafenberg, 14473 Potsdam, Germany

⁸⁻⁹ University of Leeds, School of Earth and Environment, Leeds LS2 9JT, UK

⁹⁻¹⁰ University of Exeter, Department of Mathematics, Exeter EX4 4QF, UK

¹⁰⁻¹¹ [Univ. Grenoble Alpes, Université de Toulouse, Météo-France, CNRS, Météo-France–CNRS, CNRM UMR 3589, Centre d'Etudes de la Neige, Grenoble, France](#)

¹² [Met Office Hadley Centre, FitzRoy Road, Exeter, EX1 3PB, UK](#)

¹¹⁻¹³ University of Hamburg, CLISAP, Hamburg, Allende-Platz 2, 20146 Hamburg Germany

Correspondence to: Julia Boike (Julia.Boike@awi.de)

Abstract. Most of the world's permafrost is located in the Arctic, where its frozen organic carbon content makes it a potentially important influence on the global climate system. The Arctic climate appears to be changing more rapidly than the lower latitudes, but observational data density in the region is low. Permafrost thaw and carbon release into the atmosphere, [as well as snow cover changes, are-is-a](#) positive feedback mechanisms [that has-have](#) the potential for climate warming. It is therefore particularly important to understand the links between the energy balance, which can vary rapidly over hourly to annual time scales, and permafrost conditions, which changes slowly on decadal to centennial timescales. This requires long-term observational data such as that available from the Samoylov research site in northern Siberia, where meteorological parameters, energy balance, and subsurface observations have been recorded since 1998. This paper presents the temporal data set produced between 2002 and 2017, explaining the instrumentation, calibration, processing and data quality control. [Furthermore, we present a merged dataset of the parameters, which were measured from 1998 onwards.](#) Additional data include a high-resolution digital terrain model (DTM) obtained from terrestrial LiDAR laser scanning. Since the data provide observations of temporally variable parameters that influence energy fluxes between permafrost, active layer soils, and the atmosphere (such as snow depth and soil moisture content), they are suitable for calibrating and quantifying the dynamics of permafrost as a component in earth system models. The data also include soil properties beneath different microtopographic features (a polygon center, a rim, a slope, and a trough), yielding much-needed information on landscape heterogeneity for use in land surface modeling.

For the record from 1998 to 2017, the average mean annual air temperature was -12.3 °C, with mean monthly temperature of the warmest month (July) recorded as 9.5 °C and for the coldest month (February) -32.7 °C. The average annual rainfall was 169 mm. The depth of zero annual

amplitude ~~level~~niveau is at 20.8-75 m. ~~At this depth, the temperature , and hashas warmed~~
~~increased~~ from -9.1 °C in 2006 to -7.7 °C in 2017.

The presented data are available ~~in the supplementary material of this paper and~~ through the
60 PANGAEA (<https://doi.pangaea.de/10.1594/PANGAEA.891142>) and Zenodo
(<https://zenodo.org/record/2223709>, <https://zenodo.org/record/2222454>,
<https://zenodo.org/record/2222569>) websites.

65 1 Introduction

Permafrost, which is defined as ground that remains frozen continuously for two years or more, underlies large parts of the land surface in the northern hemisphere, amounting to about 15 million km² (Aalto et al., 2018; Brown et al., 1998; Zhang et al., 2000). The temperature range and the water and ice content of the upper soil layer of seasonally freezing and thawing ground (the active layer) determine the biological and hydrological processes that operate within this layer. Warming of permafrost over the last few decades has been reported from many circum-Arctic boreholes (Biskaborn et al., 2018; Romanovsky et al., 2010). Warming and thawing of permafrost and an overall reduction in the area that it covers have been predicted under future climate change scenarios by the CMIP5 climate models, but at widely varying rates (Koven et al., 2012; McGuire et al., 2018). Continued observations, not only of the thermal state of permafrost but also of the multiple other types of data required to understand the changes to permafrost, are therefore of great importance. The data required include information on conditions at the upper boundary of the soil (specifically on snow cover), on atmospheric conditions, and on various subsurface state variables (such as, e.g., soil volumetric liquid water content and soil temperature). The seasonal snow cover in Arctic permafrost regions can blanket the land surface for many months of the year and has an important effect on the thermal regime of permafrost-affected soils (Langer et al., 2013). The soil's water content determines not only its hydrological and thermal properties, but also the energy exchange (including latent heat conversion or release) and biogeochemical processes.

85 In view of these dependencies, the data sets presented here, including snow cover and the thermal state of the soil and permafrost, together with meteorological data, will be of great value (i) for evaluating permafrost models or land surface models, (ii) for satellite calibration and

validation (cal/val) missions, (iii) in continuing baseline studies for future trend analysis (for example, of the permafrost's thermal state), and (iv) for biological or biogeochemical studies.

90 The Samoylov research site in the Lena River Delta of the Russian Arctic has been investigated by the Alfred Wegener Institute Helmholtz Center for Polar and Marine Research (AWI), in collaboration with Russian and German academic partners, since 1998. The land surface characteristics and basic climate parameter data collected between 1998 and 2011 have been previously published in Boike et al. (2013). Major developments in earth system models, for
95 example through the European PAGE21 project (www.page21.org), the Permafrost Carbon Network projects (www.permafrostcarbon.org), satellite calibration and validation missions, and observations through the Global Terrestrial Network on Permafrost (GTN-P) have subsequently led to sustained interest from a broader modelling community in the data obtained.

In this publication we provide information on the research site and a full documentation of the
100 data set collected between 2002 and 2017, which can be used for forcing and validation of earth system models (see e.g. Chadburn et al., 2015; Chadburn et al., 2017; Ekici et al., 2014; Ekici et al., 2015). We present data that incorporate subsurface thermal and hydrologic components, of heat flux as well as snow cover properties, and meteorological data from the Samoylov research site, similar to the data published previously for a Spitsbergen permafrost site (Boike
105 et al., 2018).

2 Site description

The Samoylov research site is located within the continuous permafrost zone on Samoylov Island in the Lena River Delta, Siberia (Figure 1). It has been a site for intensive monitoring of soil temperatures and meteorological conditions since 1998 (Boike et al., 2013).

110 The region is characterized by an Arctic continental climate with low mean annual air temperature of below -12 °C, very cold minimum winter air temperatures (below -45 °C), and summer air temperatures that can exceed 25 °C, a thin snow cover and a summer water balance equilibrated between precipitation input and evapotranspiration (Boike et al., 2013).

The study area of the Lena River Delta has permafrost to depths of between 400 and 600 m
115 (Grigoriev, 1960). The active layer thawing period starts at the end of May and active layer thickness reaches a maximum at the end of August/beginning of September. Marked warming of this area over the last 200 years has been inferred from temperature reconstruction using deep borehole permafrost temperature measurements in the delta and the broader Laptev Sea region (Kneier et al., 2018).

120 Samoylov Island is located within a deltaic setting, consists of a flood plain in the western part of the island and a Holocene terrace characterized by ice-wedge polygonal tundra and larger waterbodies in the eastern part (Figure 1).

The area is generally characterized by ice-rich organic alluvial deposits, with an average ice content in the upper meter of more than 65% by volume for the Holocene terrace and of about
125 35% for the flood plain deposits (Zubrzycki et al., 2013). The Holocene terrace is dominated by ice wedge polygons so that a considerable volume of the upper soil layer (0–10 m) is characterized by excess ground ice (Kutzbach et al., 2004). Degradation of ice wedges, as observed throughout the Arctic (Liljedahl et al., 2016), occurs at only a-few, localized parts of the research site (Kutzbach, 2006). The recent work by Nitzbon et al. (2018) shows that the
130 spatial variability in the types of ice-wedge polygons observed at this study area can be linked to the spatial variability in the hydrological conditions. Furthermore, wetter hydrological conditions have a destabilizing effect on ice wedges and enhance degradation.

The total mapped area of the polygonal tundra on Samoylov Island (excluding the floodplain) is composed of 58% dry tundra, 17% wet tundra and 25% water surfaces, ~~thereof~~ which 10%
135 are overgrown water and 15% open water (Muster et al., 2012, Figure 3a). The landscape is characterized by polygonal tundra, i.e. a complex mosaic of low- and high-centered polygons (with moist to dry polygonal ridges and wet depressed centers) and larger waterbodies (Muster, 2013; Muster et al., 2012). The polygonal tundra microtopography, polygon rims, slopes, and depressed centers are clearly distinguishable. Depressed polygon centers are typically water-
140 saturated or have water levels above the ground surface (shallow ponds). High-centered polygons have inverse microtopography, i.e. drier elevated centers and wet surrounding troughs. Polygonal ponds and troughs make up about 35% of the total water surface area on the island (Boike et al., 2013).

Previous research based at the research site has focused on greenhouse gas cycling (Abnizova
145 et al., 2012; Knoblauch et al., 2018; Knoblauch et al., 2015; Kutzbach et al., 2004; Kutzbach et al., 2007; Langer et al., 2015; Runkle et al., 2013; Sachs et al., 2010; Sachs et al., 2008; Wille et al., 2008), aquatic biology (Abramova et al., 2017), upscaling of land surface characteristics and parameters from ground-based data to remote sensing data (Cresto Aleina et al., 2013; Muster et al., 2013; Muster et al., 2012), and hydrology (Boike et al., 2008b; Fedorova et al.,
150 2015; Helbig et al., 2013). Data from a few years have also been used in earth system modeling (Chadburn et al., 2015; Chadburn et al., 2017; Ekici et al., 2014; Ekici et al., 2015) and for modeling land surface, snow, and permafrost processes (Gouttevin et al., 2018; Langer et al., 2016; Westermann et al., 2016; Westermann et al., 2017; Yi et al., 2014). Table 1 summarizes the characteristics of the research site, based on data in previous publications and additional
155 data included in this paper.

3 Data description

There are three data sets presented in this paper. This paper presents for the first time a complete data archive and descriptions in the form of the following data sets: (i) a full range of meteorological, soil thermal, and hydrologic data from the research site covering the period between 2002 and 2017 (Figure 2), (ii) high spatial resolution data from terrestrial laser scanning of the research site completed in 2017, with resulting data sets for a digital terrain model and for vegetation height, (iii) time-lapse camera images, and (iv) a data set containing specially compiled or processed data sets for those parameters that were measured in the period from 1998 to 2002, thus extending the record to form a long-term data set, as initiated in Boike et al. (2013). The first data set provides, for the first time, a full range of meteorological, thermal, and hydrologic data including a complete description and data archive of all parameters measured at the research site (Figure 2) between 2002 and 2017. The second data set contains data, specially compiled or processed datasets for those parameters that have been measured in the period from 1998 to 2002 to obtain a long term data set, as initiated in Boike et al. (2013). The processing and level structure is described in detail in Section 4. The third data set comprises high spatial resolution data from terrestrial laser scanning of the research site completed in 2017, with resulting data sets for a digital terrain model and for vegetation height. Additional data such as soil properties and soil carbon content are also included in this paper in order to provide a complete set of data and parameters suitable for earth system, conceptual and land surface modeling. All of these data are archived in the PANGAEA data libraries and the measuring principles and analysis are described in this paper.

Data logging between 2002 and 2013 at the research site was powered by a solar panel and a wind turbine generator and the data was retrieved manually during site visits once or twice a year, when visual inspections were also made of the sensors. Data gaps prior to 2013 resulted

180 mainly from problems with the site's energy supply, such as problems with the solar/wind
charge controller. No other gap filling has been undertaken, but previous publications (e.g.
Langer et al., 2013) suggest that reanalysis data, such as ERA-Interim, could be used for this
purpose. In Chadburn et al. (2017), a method for correcting reanalysis data to better represent
the site is described and applied. [The gap-free meteorological dataset that was produced and
185 used in Chadburn et al. \(2017\) is now available on the PANGAEA database \(Burke et al. 2018\),
making it easy for modellers to begin running the Samoylov site and therefore to make good
use of our data.](#)

Since 2013 the research site has been connected to the main electricity supply of the new
Russian Research Station, resulting in much improved data collection with almost no data gaps.

190 Details of the sensors used are provided in the following sections, as well as descriptions of the
data quality and cleaning routine (Section 4). The instruments can be divided into above-ground
sensors (meteorological) and below-ground sensors (e.g. soil sensors). Further detailed
information on the sensors can be found in Table 2, which summarizes all of the instruments
and relevant parameters, as well as in the appendices B to H (metadata, description of
195 instruments, and calculations of final parameters). Figure 2 presents a time series of [selected all](#)
parameters measured between 2002 and 2017.

3.1 Meteorological station data

The standard meteorological variables described in this section were averaged over various
intervals (Table 2) with the averages, sums, and individual values all being saved hourly until
200 2009 and half-hourly thereafter. The sampling intervals changed as a result of different logger
and sensor setups and different available power sources. Sensors were connected directly to
data loggers. A number of different data logger models from Campbell Scientific were used

over the years (CR10X between 2002 and 2009, CR200 between 2007 and 2010, and CR1000 since 2009), together with an AM16/32A multiplexer.

205 **3.1.1 Air temperature, relative humidity**

Air temperature and relative humidity were measured at 0.5 m and 2 m above the ground (starting with hourly averages at 2.0 m until 30 June 2009 and at 0.5 m until 26 July 2010, with half-hourly averages thereafter) using Rotronic and Vaisala air temperature and relative humidity probes protected by unventilated shields (Figure B1 and Table 2). According to the
210 sensor's manuals, the HMP45 sensors have a measurement limit of -39.2 °C, but we recorded data down to -39.8°C.- During extreme cold air temperature periods, for example, between 1 February and 15 March, 2013, ~~stagnant~~constant air temperature values were recorded at the sensor's output limit. These data periods were manually flagged ([Flag 6: consistency; Table 3](#)~~Flag Nr. 6~~) using a lower temperature limit of -39.5 °C.

215 Also of importance is the decrease in accuracy of the air temperature and humidity data with decreasing temperature and moisture content. For example, the accuracy for the HMP45A sensor at 20 °C is ± 0.2 °C, but at -40 °C it is ± 0.5 °C. Campbell Scientific PT100 temperature sensors were installed on 22 August 2013 ~~in parallel~~alongside ~~with~~ the temperature and humidity probes, at the same heights but in separate unventilated shields, in order to circumvent
220 this problem. Since 17 September 2017 Vaisala HMP155A air temperature and relative humidity probes were installed which enable the full range of temperatures (below -40 °C). The uncertainty in all the temperature measurements ranges between 0.03 and 0.5 °C, depending on the sensors used; the uncertainty in the relative humidity measurements ranges between 2 and 3%. The measurement heights were not adjusted with respect to the snow surface during periods
225 of snow cover accumulation or ablation. The lower probes (at 0.5 m) were only completely snow-covered during two months of the 2017 winter season (16 April–11 June 2017), as

observed in photographic images, and therefore this time period is flagged in the data series (Flag 8: snow-covered; Table 3).

3.1.2 Wind speed and direction

230 The wind speed and direction were measured using a propeller anemometer (R.M. Young Company 05103, Figure B2), which was ~~aligned~~calibrated towards geographic north. This was done by orienting the center line of the sensor towards true north (using a GPS reference point) and then rotating the sensor base until the datalogger indicated zero degrees. The averaged wind direction, its standard deviation, and the wind speed were all recorded at hourly intervals until
235 30 June 2009 and at half-hourly intervals thereafter. Since August 2015, wind maximum and minimum wind speed are also recorded. The mean wind speeds and directions were calculated using every value recorded during the measurement interval. The standard deviation of the wind direction was calculated using the algorithm provided by the Campbell Scientific data logger.

3.1.3 Radiation

240 The net radiation was measured between 2002 and 2009 using a Kipp & Zonen NR LITE net radiometer; outgoing longwave radiation was also measured using a Kipp & Zonen CG1 pyrgeometer. Since 2009, various 4-component radiometers were used (Table 2). The averaged values were stored at hourly intervals until 30 June 2009 and at half-hourly intervals thereafter. Further details of the measuring periods and the specifications for the different sensors can be
245 found in Table 2. Although all radiation sensors were checked for condensation, dirt, physical damage, hoar frost, and snow coverage during the regular site visits, the instruments were largely unattended and their accuracy is therefore estimated to have been $\pm 10\%$. Our quality analysis also includes flagging the data during those periods where short wave incoming radiation was lower than shortwave outgoing radiation by 10 W m^{-2} using Flag 6 (plausibility,

250 [values unlikely in comparison with other sensor series or for a given time of the year\). Between
June 30, 2009 to July 21, 2017, less than 1% of the data were flagged.](#) Since August 2014 a
Kipp & Zonen CNR4 four-component radiation sensor is operative, together with a CNF4
ventilation unit to prevent condensation (Figure B3). The additional heating available for the
CNR4 sensor was never used.

255 **3.1.4 Rainfall**

Un-heated and un-shielded tipping bucket rain gauges (Environmental Measurements ARG100
and R. M. Young Company model 52203) were installed directly on the ground on 31 August
2002 (ARG100) and 26 July 2010 (52203). The Environmental Measurements ARG100 liquid
precipitation probe was damaged during the winter of 2009/2010. By installing the gauge close
260 to the ground the risk of wind-induced tipping of the bucket which would lead to false data
records, can be reduced (as observed by Boike et al., 2018). Due to the typically low snow
heights, the risk of snow coverage of the instrument is also very low.

The instruments measure only liquid precipitation (rainfall) and not winter snowfall. The
tipping buckets were checked regularly during every summer by pouring a known volume of
265 water into the bucket and carrying out frequent visual inspections for dirt or snow during each
site visit. [These calibration data are flagged with Flag 3 \(maintenance periods\).](#)

3.1.5 Snow depth

The snow depth around the station has been continuously monitored since 2002 using a
Campbell Scientific SR50 sonic ranging sensor (Figure B4). The sensor measures distance
270 between the sensor and an object or surface which could be the upper surface of the snow (in
winter), or the water surface, ground surface, or vegetation (in summer). On 17 July 2015 a
metal plate was placed directly beneath the ultrasonic beam to reduce the amount of noise in

the reflected signal due to surface vegetation (Figure B4). The acoustic distance data obtained from the sonic sensor were temperature-corrected using the formula provided by the manufacturer (Appendix C) using the air temperature measured at the Samoylov meteorological station.

To obtain the snow depth, the distance of the sensor from the surface was recorded over the summer and the mean calculated. The recorded (corrected) winter distances are then subtracted from this mean (previous) summer value to obtain snow depth. Due to seasonal thawing the ground surface can subside by a few centimeters over the summer season (and therefore no longer be set to zero) resulting in negative heights for the ground surface level being computed. In contrast, vegetation growth and higher water levels (e.g. as observed in 2017) will result in positive heights. The distance measurements collected during the snow-free season are not removed from the series or corrected since they provide potentially useful information about these processes.

The SR50 sensor acquires data over a discoidal surface with a radius that ranges from 0.23 m (0.17 m²) in snow-free conditions to 0.19 m (0.12 m²) with 20 cm of snow. This footprint disk is located in the center of a low-centered polygon for which the spatial variability of snow has been investigated by Gouttevin et al. (2018). The microtopography of this polygonal tundra (characterized by rims, slopes and polygon centers) was identified as a profound driver of spatial variability in snow depth: at maximum accumulation in 2013 rims typically had 50% less snow cover and slopes 40% more snow cover than polygon centers. However, the snow cover within each topographical unit also exhibited spatial variability on a decimeter scale (Gouttevin et al., 2018, [Figure 4](#)), probably resulting from underlying micro relief (notably vegetation tussocks) and processes such as wind erosion. This variability can affect the

representativity of the SR50-measured snow depth data and visual data obtained from time-lapse photography can therefore be extremely important (see next section).

3.1.6 Time lapse photography of snow cover and land surface

In order to monitor the timing and pattern of snow melt an automated camera system (Campbell Scientific CC640) was set up in September 2006 to photograph the land surface in the area in which the instruments were located (Figures B5 to B7). The images are used as a secondary check on the snow cover figures obtained from the depth sensor and are also valuable for monitoring the spatial variability of snow cover across polygon microtopography. During the polar night the image quality was found to be somewhat reduced and a second camera with a better resolution (Campbell Scientific CC5MPX) was therefore installed in August 2015 to record high-quality images in low-light conditions over the winter period.

3.1.7 Atmospheric pressure

A Vaisala PTB110 sensor in a vented box was installed next to the data loggers at the meteorological station (Figure B1) in August 2014 to measure atmospheric pressure.

3.1.8 Water levels

The suprapermafrost ground water level, i.e. water level of the seasonally thawed active layer above the permafrost table within one polygon, was estimated using Campbell Scientific CS616 and CS625 water content reflectometer probes installed vertically in the soil and air, with the sensor's ends standing upright (Appendix D). The advantage of this method is that the sensor can remain in the soil during freezing and subzero temperatures, whereas pressure transducers need to be removed over winter and then reinstalled. [For the unfrozen periods, the soil as](#)

~~measured by a dielectric device is a mixture of air, water, and soil particles. For the unfrozen periods, a mixed signal is recorded from air, soil, and water.~~

The sensor outputs a ~~single-signal~~ period measurement from which usually the bulk dielectric number ~~is calculated. The dielectric number (also referred to as the relative permittivity or dielectric constant) is then used to calculate the~~ and volumetric water content ~~is calculated~~ using an empirical polynomial calibration provided by the manufacturer. We use the signal period output of the CS616 and CS625 water content reflectometer probes (Campbell Scientific, 2016) and a site-specific calibration to convert to water level with respect to the sensor base (Appendix
325 D).

3.2 Subsurface data on permafrost and the active layer

3.2.1 Instrument installation ~~at~~ the soil station and soil sampling

In order to take into account any possible effects of heterogeneity in vegetation and microtopography at the research site (e.g. due to the presence of polygons), instruments for
330 measuring the soil's thermal and hydrologic dynamics (Table 2) were installed at a number of different positions within a low-centered polygon.

Instrument installation and soil sampling in 2002

A new measurement station was established in [August](#) 2002, with instruments installed in four profiles (Appendices B2 and F). Four pits were dug through the active layer and into the
335 permafrost (Figures B8 and B9), one at the peak of the elevated polygon rim (BS-1), one on the slope (BS-2), a third in the depressed center (BS-3), and one above the ice wedge (Wille et al., 2003).

The surface was carefully cut and the excavated soil stockpiled separately according to depth and soil horizon in order to be able to restore the original profile following instrument
340 installation. The soil material is generally stratified fluvial (and aeolian) sands and loams, with layers of peat. The BS-1 and BS-2 soil profiles are classified as *Typic Aquiturbels* while the BS-3 soil profile is classified as *Typic Historthel*, according to US Soil Taxonomy (Soil Survey Staff, 2010). The ~~unfrozen topsoil layer~~ thaw depth was between 17 and 40 cm thick at the time of instrument installation.

345 Sensors were installed to cover the entire depth range of the profile, i.e. from the very top, through the active layer and into the permafrost soil. The sensors were positioned according to the soil horizons so that every horizon in the profile ~~contained at least one probe~~ was probed at least once.

Sensors were installed horizontally into the undisturbed soil profile face beneath different
350 microtopographical features and the pits were then backfilled (Figures B10 and B13)).

Soil samples were collected before instrument installation so that physical parameters could be analyzed. Soil properties within the soil profiles, including the soil organic carbon (OC) content, nitrogen (N) content, soil textures, bulk densities, and porosities can be found in Appendix F.

The *Typic Aquiturbels* from the peak and the slope of the polygon rim show cryoturbation
355 features due to the formation of thermal contraction polygons. The *Typic Historthel* in the polygon center, on the other hand, does not have any cryoturbation features and is characterized by peat accumulation under water-logged conditions. (Figure F1).

3.2.2 Soil temperature

Soil temperature sensors were installed over vertical 1D profiles in 2002 beneath a polygon
360 center, slope, and rim. A measurement chain of temperature sensors was also installed in the

ice wedge down to a depth of 220 cm. Their positions are shown in Figure B13. The temperatures were initially measured using Campbell Scientific 107 thermistors connected to a Campbell Scientific CR10X data logger with a Campbell Scientific AM416 multiplexer. Campbell Scientific's "worst case" example, with all errors considered to be additive, is given as ± 0.3 °C between -25 and 50 °C. The average deviation from 0 °C determined through ice bath calibration prior to installation was 0.008 °C (maximum: 1.0 °C; minimum: -0.56 °C, standard deviation: 0.33 °C). The sensors cannot be re-calibrated once they have been installed. Phase change temperatures during spring thaw and fall refreezing are stable (the zero-curtain effect in freezing and thawing soils of periglacial regions). Assuming that freezing point depression (due to the soil type and soil water composition) does not change significantly from year to year, these periods can be used to evaluate sensor stability. Between 2002 and 2009 the data logger and multiplexer were not replaced which resulted in a reduced accuracy of up to ± 0.7 °C during the winter freeze-back periods in 2009 for two of the sensors near to the surface (center of the polygon at -1 cm, rim of the polygon at -2 cm below ground surface, respectively).

The zero curtain period during fall – winter, where temperatures in the ground are stabilized at 0°C during phase change, offers an accuracy test for sensors that cannot be retrieved. For the remaining sensors the accuracy was better, up to ± 0.5 °C. The affected data are flagged in the data series (Flag 7: decreased accuracy; Table 3). The data quality improved greatly following the installation of a new data logger and multiplexer system (Campbell Scientific CR1000 data logger, AM16/32A multiplexer) in 2010 and the maximum offset at 0 °C during freeze-back was ± 0.3 °C.

3.2.3 Soil dielectric number, volumetric liquid water content, and bulk electrical conductivity

Time-domain reflectometry (TDR) probes were installed horizontally in three soil profiles adjacent to the temperature probes. The fourth profile in the ice wedge records only temperature data (see Section 3.2.2., Figures B11 and B13). The TDR probes automatically record hourly measurements of bulk electrical conductivity (from 25 July 2010 only) and the dielectric number, obtained by measuring the amplitude of the electromagnetic wave over very long time periods and the ratio of apparent probe length to real probe length (the L_a/L ratio), corresponding to the square root of the dielectric number. A Campbell Scientific TDR100 reflectometer was used together with an SDMX50 coaxial multiplexers, ~~30~~[custom made-20](#) cm TDR probes (Campbell Scientific CS605) connected to a Campbell Scientific CR10X data logger between 2002 and 2010 and to a Campbell Scientific CR1000 data logger thereafter. All TDR probes were checked for offsets following the method described in Heimovaara and de Water (1993) and in Campbell Scientific's TDR100 manual (Campbell Scientific, 2015). The calibration delivered a probe offset of 0.085 (an apparent length value used to correct for the portion of the probe rods that is covered with epoxy) which was used instead of the value of 0.09 suggested by Campbell Scientific. The dielectric number ϵ (dimensionless) and the computed volumetric liquid water values θ_l (volume/volume) in frozen and unfrozen soil are provided as part of the time series data set. The calculation for volumetric liquid water content takes into account four phases of the soil medium (air, water, ice, and mineral) and uses the mixing model from Roth et al. (1990) (Appendix C).

The data are generally continuous and of high quality, and the absolute accuracy is estimated to be better than 5%. This is estimated from the maximum deviation of calculated volumetric liquid water content below and above the physical limits (between 0–1 or 0–100%). A probe located at 0.37 m depth beneath the polygon rim showed a shift of about 3% (up and down) in

the volumetric liquid water content during the summers of 2009, 2013, and 2014, for which we could not find any technical explanation. This shift is flagged in the data series (Flag 6: consistency; Table 3).

410 Time-domain reflectometry was also used to measure the bulk soil impedance, which is related to the soil's bulk electrical conductivity (BEC). These data were used to infer the electrical conductivity of soil water and solute transport over a twelve-month period in the active layer of a permafrost soil (Boike et al., 2008a). The impedance can be determined from the attenuation of the electromagnetic wave traveling along the TDR probe after all multiple
415 reflections have ceased and the signal [has](#) stabilized. The bulk conductivities were recorded hourly using the TDR setup described above in this section. Because no calibration was done, [and the TDR probes were custom made to 20 cm](#), a probe constant (K_p) of 1 was used for BEC waveform retrieval; Campbell Scientific suggests a K_p for the CS605 probes of 1.74. Measurements of electrical conductivity and the dielectric number were affected by irregular
420 spikes and possibly also by sensor drift similar to that in the soil temperature measurements [and thus flagged until August 2015 \(Flag 6\)](#). Data quality improved significantly after August 2015 when the Campbell Scientific coaxial SDM~~X~~50 multiplexers were exchanged for SDM8X50 and the electrical grounding system [was](#) improved. The dielectric numbers, computed volumetric liquid water contents, and soil bulk electrical conductivities can be found in the time
425 series data set.

3.2.4 Ground heat flux

Two Hukseflux HFP01 heat flux plates were installed on 24 August 2002 and recorded ground heat flux at 0.[06 \(rim\)](#)~~18~~ and 0.[1124](#) m [\(center\)](#) depth since then (Figure B12). The manufacturer's calibration values were used to record heat flux in $W m^{-2}$ (Hukseflux, 2016).

430 Downward fluxes are positive and occur during spring and summer while upward heat fluxes are negative and typically occur during fall and winter.

3.2.5 Permafrost temperature

The monitoring of essential climate variables (ECV's) for permafrost has been delegated to the Global Terrestrial Network on Permafrost (GTN-P) which was developed in the 1990s by the
435 International Permafrost Association under the World Meteorological Organization. The GTN-P has established permafrost temperature and active-layer thickness as ECV's in (1) the TSP (Thermal State of Permafrost) data set and (2) the CALM (Circumpolar Active Layer Monitoring) monitoring program (Romanovsky et al., 2010; Shiklomanov et al., 2012). A 27 m deep borehole was drilled in March 2006 with the objective to establish permafrost
440 temperature monitoring (Figure 1, Appendix E). A 4 m long metal pipe (diameter 13 cm; extending 0.5 m above and 3.5 m below the surface) was used for stability and to prevent the inflow of water during summer season when the upper ground is thawed. 24 thermistors (RBR thermistor chain with an RBR XR-420 logger) were installed in August 2006, one at the ground surface and 23 between 0.75 m and 26.75 m depth, inside a PVC tube (Figure E2). A second
445 PVC tube was inserted into the borehole and the remaining air space in the borehole was backfilled with dry sand. Temperatures were recorded at hourly intervals, with no averaging; no data was recorded between September 2008 and April 2009. We recommend that the temperature data from the sensors at the ground surface, at 0.75, 1.75 and 2.75 m depths should not be used due to the possibility of it having been affected by the metal access pipe. The data
450 from these sensors have not been flagged as they are of high quality, but they may not provide an accurate reflection of the actual temperatures. They show above zero temperatures down to 1.75 m during summer in contrast to the active layer soil temperatures (Figure 2). In contrast, CALM active layer thaw never exceeded > 0.8 m since 2002 at all grid locations.

The second PVC tube was used for comparison measurements at the same depths in the
455 borehole. The differences between the calibrated reference thermometer (PT100) showed
values between ± 0.03 and ± 0.33 °C (Appendix E, Table E1).

The data record shows that depth of zero annual amplitude (ZAA, where seasonal temperature
changes are negligible, ≤ 0.1 °C) is located below 20.75 m. At 26.75 m, temperatures fluctuate
with a maximum of 0.05 °C. The annual mean temperatures between the start and end of the
460 time series, as well as minimum and maximum temperatures, are displayed in Figure 3
("trumpet curve"). The permafrost warms at all depths within this 10-year period, most
pronounced at the surface. At 2.75 m, the mean annual temperature increased by 5.7 °C (from
-9.2 to -3.5°C), at 10.75 m by 2.8 °C (from - 9.0 to -6.2 °C) and at ZAA of 20.75 m by 1.3 °C
(from -9.1 to -7.7 °C).

465 **3.2.6 Active layer thaw depth**

Active layer thaw depth measurements have been carried out since 2002 at 150 points over a
27.5×18 m measurement grid (Boike et al., 2013, Figure 12; Wille et al., 2003; Wille et al.,
2004), by pushing a steel probe vertically into the soil to the depth at which frozen soil provides
firm resistance. The data are recorded at regular time intervals, usually between June/July and
470 the end of August, when the research site is visited. The data set shows that thawing of the
active layer continues until mid-September in some years (e.g. in 2010 and 2015). Large
interannual variations in maximum active layer thaw depths are recorded at the end of August,
ranging between a largest mean thaw depth of about 0.57 m (2011) and a smallest mean of 0.41
m (2016).

475 To assist in the interpretation of active layer thickness data, surface elevation change
measurements (subsidence measurements) have been collected since 2013 at three locations

(two wet centers, one rim) using reference rods installed deep in the permafrost (Figure 1). These measurements show that a net subsidence of about 15 cm occurred between 2013 and 2017 at the rim, and smaller subsidence (-1 cm and -3 cm) at the wet centers. A net subsidence of between -1.4 to -19.4 cm between 2013 and 2017 was reported by Antonova et al. (2018) for the Yedoma region of the Lena River Delta. Subsidence monitoring will in future be incorporated into the observational program on Samoylov Island so that active layer thaw depths can be more accurately interpreted taking into account surface changes due to subsurface excess ice melt.

485 **4 Data quality control**

An overview of the periods of instrumentation and parameters is provided in Figure 4.

Quality control was carried out as outlined in Boike et al. (2018) for the data set compiled from the Bayelva site, which is located on Spitsbergen-permafrost. Quality control on observational data aimed to detect missing data and errors in the data, in order to provide the highest possible standard of accuracy. In addition to the automated processing, all data have been visually controlled and outliers have been manually detected, but it cannot be ~~excluded~~-ruled out that there are still unreasonable values present which are not flagged accordingly. We differentiate between Level 0, Level 1, and Level 2 data (Table 3). Level 0 are data with equal time steps (UTC), data gaps filled with NA and standardized into one file format. These data, as well as raw data, are stored internally at AWI and are not archived in PANGAEA. Level 1 data have undergone extensive quality-control and are flagged with regards to equipment maintenance periods, physical plausibility, spike/constant value detection, and sensor drift (Table 3). Level 2 data are compiled for special purposes and may include combinations of data series from multiple sensors and gap-filling. Examples in this paper of Level 2 data are soil temperature

500 and meteorological data (air temperature, humidity, wind speed, and net radiation) recorded between 1998–2002 (Boike et al., 2013) that have been combined with [a](#) data set since 2002 into a single data series, in order to obtain a long term picture (documentation of source data is provided in the PANGAEA data archives).

Nine types of quality control (flags) have been used (Table 3). Data are flagged to indicate
505 where no data is available, or system errors, or to provide information on system maintenance or consistency checks based on physical limits, gradients, and plausibility.

Due to the failure of some sensors that cannot be retrieved for repair or re-calibration (e.g. sensors installed in the ground), the initial accuracy and precision of the sensors may not always be maintained. In the case of soil temperature sensor accuracy can be estimated by analysis of
510 temperatures relative to the fall zero-curtain effect, assuming that the soil water composition is similar from year to year. Our temperature data have been checked against the fall zero-curtain effect and information on any reduction in accuracy is [flagged in the data set provided in Table 3](#) (Flag 7: decreased accuracy; [Table 3](#)). These checks are essential if subtle warming trends are to be detected and interpreted. The suitability of flagged data therefore depends on what it is to
515 be used for and the accuracy required.

The local differences between the [sensor](#) locations from 1998 and 2002 (even though less than 50 m meters apart), as well as differences between sensor types and accuracies, need to be considered when interpreting longer term records. For example, relative air humidity data show marked differences between the earlier ~~record~~ [data set](#) (1998–1999) compared to the later data
520 set (starting in 2002). Net radiation between 1998 and 2009 showed lower values during the summer periods compared to the summer periods between 2009 and 2017. One reason could be the change in sensor types: during the first period, a net radiation sensor was in place, whereas during the second period a four component radiation sensor was used.

5 Summary and Outlook

525 The climate of the period between 1998 and 2017 can be characterized as follows: The average mean annual air temperature is $-12.3\text{ }^{\circ}\text{C}$, with mean monthly temperature of the warmest month (July) recorded as $9.5\text{ }^{\circ}\text{C}$ and for the coldest month (February) as $-32.7\text{ }^{\circ}\text{C}$. The average annual rainfall was 169 mm and the average annual winter snow cover 0.3 m (2002–2017; no data are available prior to 2002 for snow cover), with a maximum snow depth of 0.8 m recorded in 2017.

530 Since the installation in 2006, permafrost has warmed by $1.3\text{ }^{\circ}\text{C}$ at the zero annual amplitude ~~niveau~~-depth at ~~20.8-75 m~~-depth. Permafrost in the Arctic has been warming and the rate of warming at this borehole is one of the highest recorded (Biskaborn et al., 2018). Mean annual permafrost temperatures have been increasing over the recording period at all depths, but the end-of-season's active layer thaw depth shows a marked interannual variation. Further analysis

535 is required to disentangle the relationships between meteorological drivers, permafrost warming, and active layer thaw depths at this research site. The data sets described in, and distributed through, this paper provide a basis for analyzing this relationship at one particular research site and a means of parameterizing earth system modelling over a long observational period. The newly collated data set will allow multi-year model validation and evaluation that

540 includes the small-scale microtopographic effects of permafrost-affected polygonal ground. Landscape heterogeneity (such as, e.g., in soil moisture) is particularly poorly represented in earth system models and yet exerts a strong influence on the greenhouse gas balance (e.g. Kutzbach et al., 2004; Sachs et al., 2010). As such, this data set allows the distinction between microtopographic units (wet vs. dry) to be incorporated into modelling.- This makes this an

545 important [dataset for modellers](#). We will continue to update these data sets for use in baseline studies, as well as to assist in identifying important processes and parameters through conceptual or numerical modeling.

6 Data availability

The data sets presented herein are freely available as a download from PANGAEA.

550 Permafrost temperature and active layer thaw depth data are also available through the Global Terrestrial Network for Permafrost (GTN-P) database (<http://gtnpdatabase.org>). All data are provided as ASCII files and are freely available through the following data provider and links:

<https://doi.pangaea.de/10.1594/PANGAEA.891142> [and and Zenodo](#)

<https://zenodo.org/record/2223709>, <https://zenodo.org/record/2222454>,

555 <https://zenodo.org/record/2222569>) with respective data sets listed in this collection for time series level 1 and 2 data, terrestrial laser scanning and time lapse camera images.

7 Figures

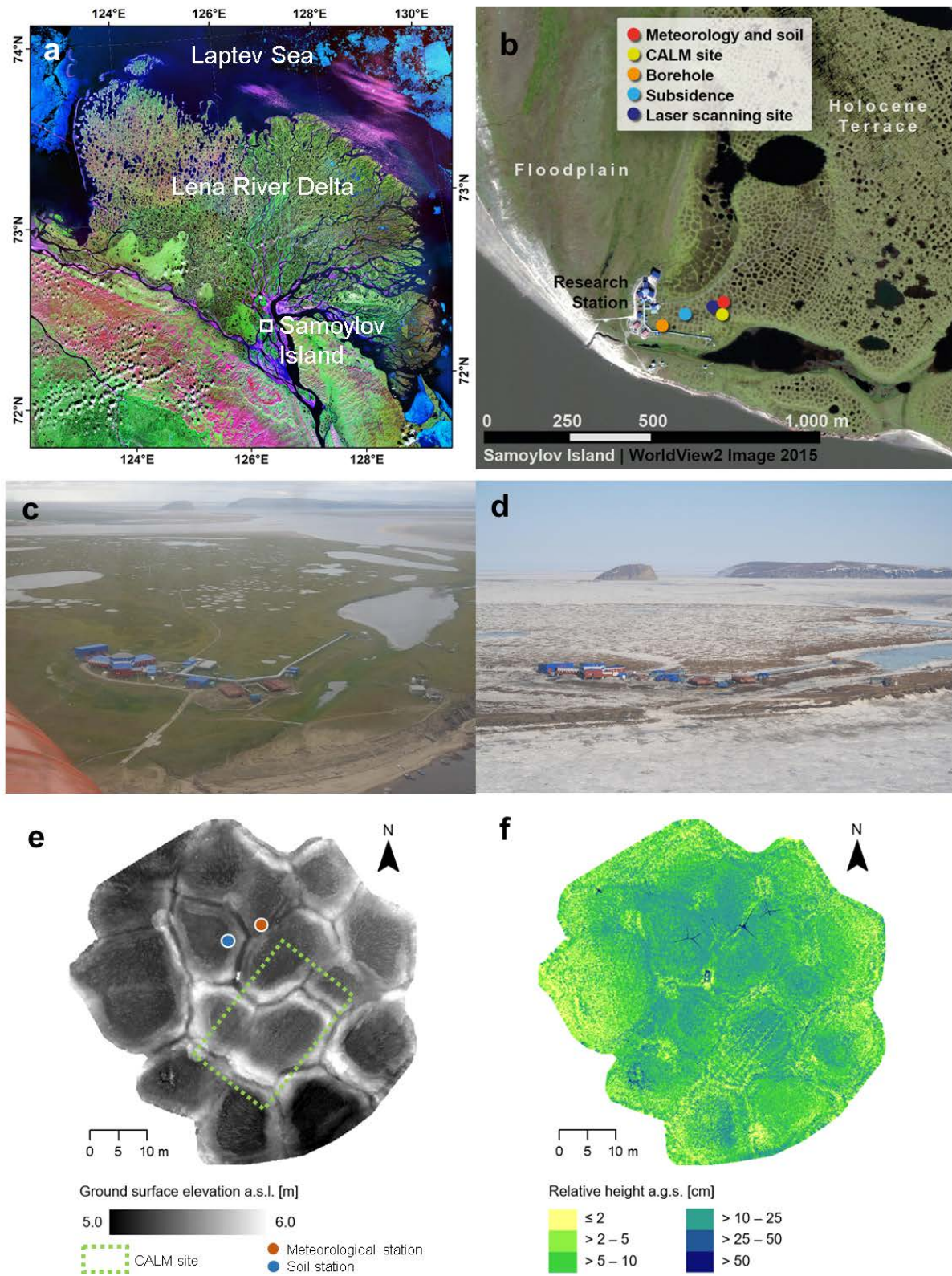

Figure 1. Samoylov research site: **(a)** Location of Samoylov Island in the Lena River Delta, north-eastern Siberia (Landsat-7 ETM+ GeoCover 2000). **(b)** Location of instrumentation and measurement sites. **(c)** The research site under summer conditions (September 2017) and **(d)** spring conditions (April 2014; photo by T. Sachs). **(e)** Digital terrain model obtained by terrestrial laser scanning (TLS) in September 2017, and **(f)** relative heights/vegetation derived from TLS data acquired in September 2017. Further details of the methods of TLS data processing are provided in Appendix H.

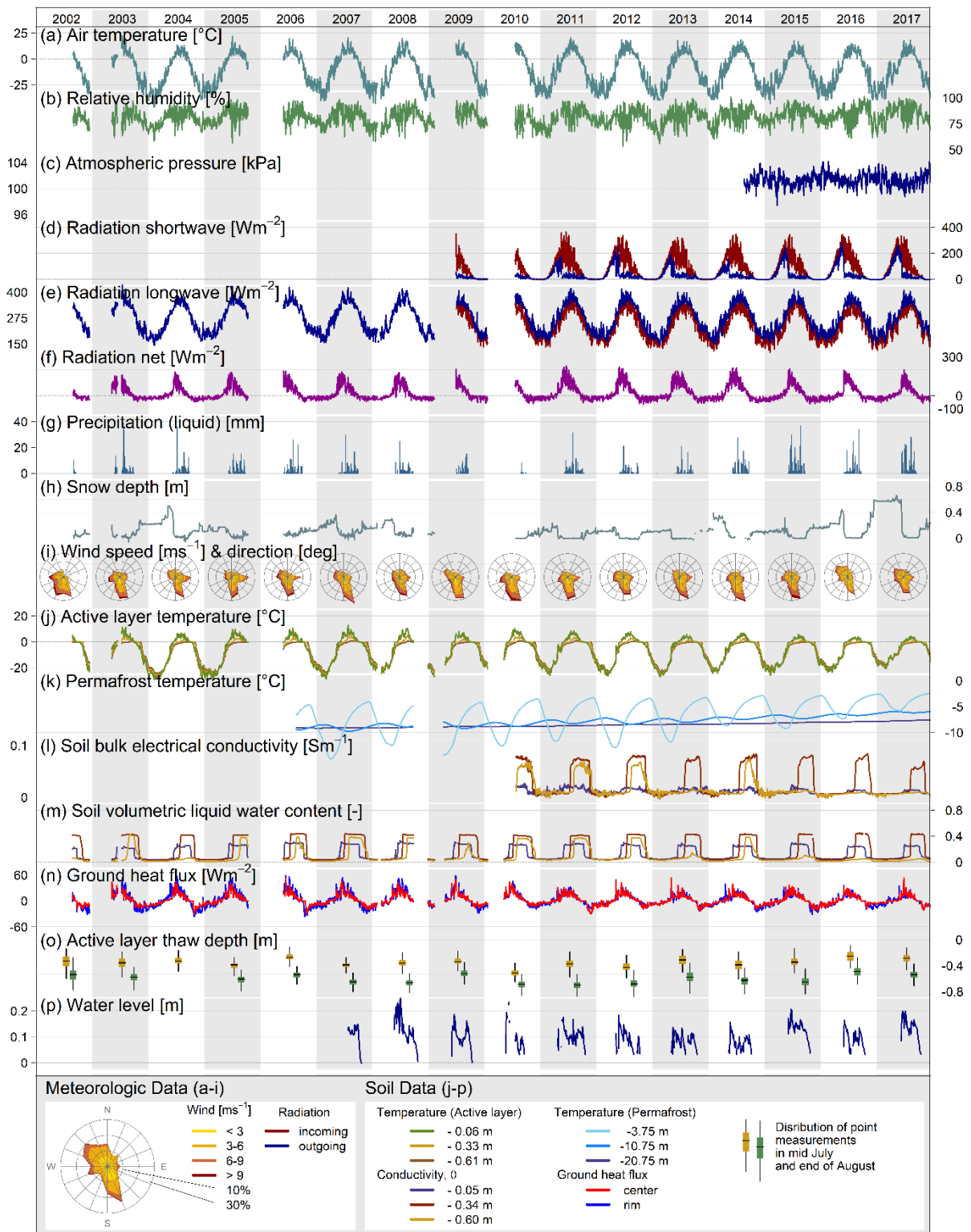

Figure 2. Time series (daily mean values) of Samoylov data presented in this paper (a)–(i): meteorological data, (j)–(p): soil data. Seasonal average active layer thaw depth (o) was measured at the 150 data points on the Samoylov CALM grid. Further details on the sensors and periods of operation are given in Table 2.

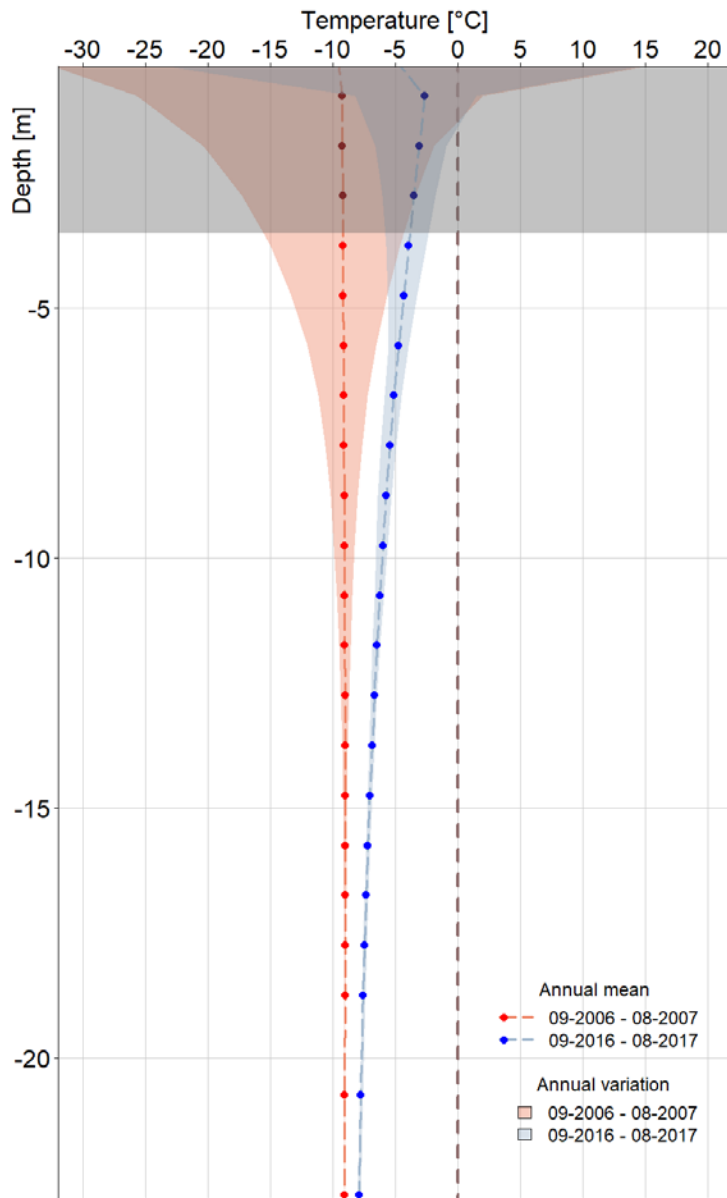
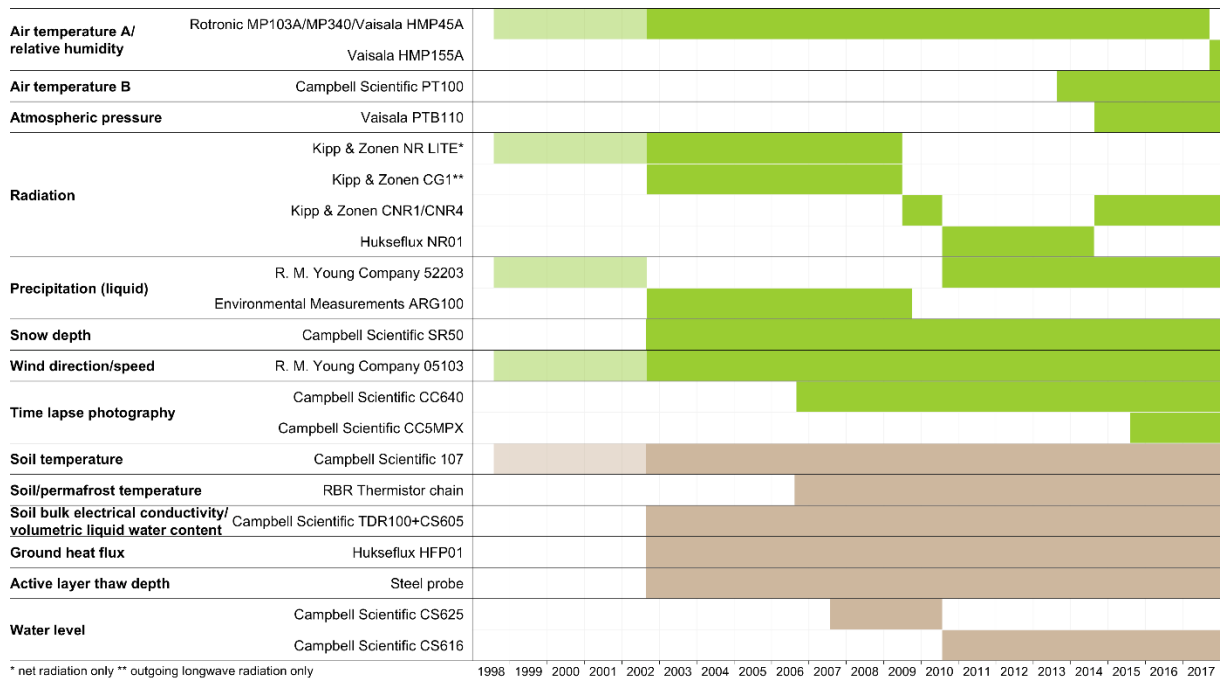

Figure 3. Mean annual, maximum and minimum permafrost temperatures at different depths between 2006 and 2017, as recorded in the Samoylov Island borehole. Mean annual temperatures are based on the period 1 September 2006 to 31 August 2007, and 1 September 2016 to 31 August 2017. Maximum and minimum annual variations are based on the same time period and computed from mean daily temperatures. The upper 3.5 m below surface are shaded in grey since we recommend not to use these data for active layer thermal processes.



580 **Figure 4.** Time line for all of the parameters recorded on the Samoylov research site between
1998 and 2017. Green bars represent above-ground sensors; brown bars represent sensors
installed below the ground surface. Dark brown and dark green coloring indicates a data set
described in this paper (2002–2017), light brown and light green coloring indicates a previously
described data set (1998–2011; Boike et al., 2013). Continuous data (light and dark colored data
585 sets, e.g. wind speed and direction) are combined in the Level 2 product as one continuous data
series for the period 1998–2017. Details of parameters for all sensors can be found in Table 2.
Note that the color bars describe the sensor installation period, but data might not be available
in the published data set due to sensor malfunction/failure. [Note that the measuring period for
the Vaisala HMP155A only started 17 September, 2017, which is why the bar appears very](#)
590 [thin. Recording of all parameters is still continuing at present.](#)

8 Tables

Table 1. Site description parameters for earth system model input. Values have been computed and compiled for the Samoylov research site and surrounding areas.

Variable	Value	Source
Surface characteristics		
Summer albedo	0.15–0.2	Langer et al. (2011a)
Summer Bowen ratio	0.35–0.50	Langer et al. (2011a)
Summer roughness length (mm)	1×10^{-3} (from eddy covariance data)	Langer et al. (2011a)
Snow properties		
Snow albedo	Spring period prior to melt: 0.8 (2007, 2008)	Langer et al. (2011a)
End of the snow ablation	26 Apr–18 Jun (1998–2017)	Boike et al. (2013); this paper
Range of snow depths (end of season before ablation) (m) recorded by the SR50 sensor (thus disregarding spatial variability in snow depth)	0.09–0.7 (1999–2017)	Boike et al. (2013) which includes two locations: 1999–2002 polygon rim; 2003–2017 polygon center
End of season snow density (kg m^{-3}) (different year and different methods)	175–225 (field measurement) 190±10 (field measurement) 264 ±24 (based on X-ray microtomography and direct numerical simulations)	Boike et al. (2013) Langer et al. (2011b) Gouttevin et al. (2018)
Snow heat capacity ($\text{MJ m}^{-3} \text{K}^{-1}$)	0.39±0.02	Langer et al. (2011b)
Snow thermal conductivity ($\text{W m}^{-1} \text{K}^{-1}$) (bulk value for snowpack overlying vegetation/grass)	0.22±0.03 (fitted from temperature profiles) 0.22 ±0.01 (based on X-ray microtomography and direct numerical simulations)	Langer et al. (2011b) Gouttevin et al. (2018)
Soil properties		
Soil classification	Complex of <i>Glacic/Typic Aquiturbels</i> and <i>Histic Aquorthels</i> according to USDA Soil Taxonomy	Kutzbach et al. (2004)
Surface organic layer thickness	0–15 cm (bare to vegetated tundra areas; up to 20 cm in wetter areas)	Boike et al. (2013)
Soil texture (below surface organic layer)	Sand to silt with organic peat layers of varying depths	Boike et al. (2013); Appendix F for single profiles
Thawed soil thermal conductivity ($\text{W m}^{-1} \text{K}^{-1}$)	0.14±0.08 (dry peat) 0.60±0.17 (wet peat) 0.72±0.08 (saturated peat)	Langer et al. (2011a)
Thawed soil heat capacity ($10^6 \text{ J K}^{-1} \text{ m}^{-3}$)	0.9±0.5 (dry peat) 3.4±0.5 (wet peat) 3.8±0.2 (saturated peat)	Langer et al. (2011a)

Variable	Value	Source
Frozen soil thermal conductivity (W m ⁻¹ K ⁻¹)	0.46±0.25 (dry peat) 0.95±0.23 (wet peat) 1.92±0.19 (saturated peat)	Langer et al. (2011b)
Soil bulk density (kg m ⁻³)	Depth average: 0.75×10 ³ kg m ⁻³	Boike et al. (2013); Appendix F
Soil carbon content (g g ⁻¹)	0.01–0.22	Boike et al. (2013)
Organic carbon stock (kg C m ⁻²)	24 (for 0–100 cm)	Chadburn et al. (2017) (spatial average); Appendix F
Saturated hydraulic conductivity (m s ⁻¹)	463×10 ⁻⁶ (moss layer) 0.3×10 ⁻⁶ (mineral layer) 10.9×10 ⁻⁶ 130x 10 ⁻⁶	Helbig et al. (2013) Ekici et al. (2015) Boike et al. (2008)
Clapp-Hornberger exponent (b factor)	~4 (organic layer, typical for organic/peat) ~4.5 (mineral layer, typical for sandy loam)	Beringer et al. (2001)
Porosity (volumetric water content at saturation)	0.95–0.99 (organic layer) 0.5–0.7 (mineral layer)	Boike et al. (2013)
Van Genuchten Parameters: Alpha (1 mm ⁻¹)	sandy loam: 6 peat/organic:10	Yang and You (2013)
Van Genuchten Parameters: n (unit-free)	sandy loam: 1.3 peat/organic: 10	Dettmann et al. (2014)
Vegetation characteristics		
Vegetation height (based on field measurements)	Wet tundra at polygon centers and on margins of polygonal ponds: moss and lichen stratum 5 cm, vascular plants stratum 30 cm. Moist (dry) tundra at polygon rims and in high-center polygons: moss- and lichen stratum 5 cm, vascular plants stratum 20 cm. Centers of polygonal and interpolygonal ponds: moss stratum: 20–45 cm, vascular plants stratum 30 cm.	Knoblauch et al. (2015); Kutzbach et al. (2004); Spott (2003); this paper
Vegetation height (Estimates from terrestrial laser scanning)	(1) derived as mean vegetation height within a radius of 3 cm - center: mean 5.4 cm/standard deviation 2.0 cm - rim: mean 4.6 cm/standard deviation 2.1 cm (2) derived as maximum vegetation height (99th percentile) within a radius of 3 cm - center: mean 11.7 cm/standard	This paper (Appendix H)

Variable	Value	Source
	deviation 4.5 cm - rim: mean 10.7 cm/standard deviation 5.2 cm	
Vegetation fractional coverage	Wet tundra at polygon centers and on margins of polygonal ponds: moss- and lichen stratum 95%, vascular plants stratum 33–55% Moist (dry) tundra at polygon rims and in high-center polygons: moss- and lichen stratum 95%, vascular plants stratum 30% Centers of polygonal and interpolygonal ponds: moss stratum: 95%, vascular plants stratum 0–20%	Knoblauch et al. (2015); Kutzbach et al. (2004); Spott (2003)
Vegetation type	Complex of G3 and W2 according to CAVM-Team (2005) Moist (dry) tundra at polygon rims and in high-center polygons: <i>Hylocomium splendens</i> – <i>Dryas punctata</i> community. Wet tundra at polygon centers and on margins of polygonal ponds: <i>Drepanocladus revolvens</i> – <i>Meesia triquetra</i> – <i>Carex chordorrhiza</i> community Centers of polygonal and interpolygonal ponds: <i>Scorpidium scorpioides</i> – <i>Carex aquatilis</i> – <i>Arctophila fulva</i> .	Boike et al. (2013); Knoblauch et al. (2015); Kutzbach et al. (2004); this paper
Max Leaf Area Index (LAI) in summer (does not include moss)	0.3 (derived from MODIS)	Chadburn et al. (2017)
Root depth	30 cm (center, rim)	Kutzbach et al. (2004)
Landscape		
Landscape type	Lowland polygonal tundra, mosaic of wet and moist sites	Kutzbach (2006); Kutzbach et al. (2004)
Bioclimate subzones	Subzone D	CAVM-Team (2005)

Table 2. List of sensors, parameters, and instrument characteristics for the automated time series data from the Samoylov research site, 2002–2017. Positive heights are above the ground surface, negative heights are below the ground surface. Sensor names refer to the original manufacturer brand name (e.g. the Vaisala PTB110 air pressure sensor is distributed by Campbell Scientific as model CS106). Integration methods are average (avg), sample (spl), and sum.

Variable	Sensor (number of sensors, if > 1)	Period of operation	Height (m)	Unit	Measuring interval	Integration method	Accuracy (\pm)	Spectral range
		from to						
Above-ground sensors								
Air temperature (A)	Vaisala HMP155A (2)	Sep 2017	now	0.5, 2.0	$^{\circ}\text{C}$	30 s	avg 30 min	$(0.226 - 0.0028 \times T)$ $^{\circ}\text{C}$ (-80 to 20 $^{\circ}\text{C}$), $(0.055 + 0.0057 \times T)$ $^{\circ}\text{C}$ (20 to 60 $^{\circ}\text{C}$)
Air temperature (A)	Rotronic MP103A/Rotronic MP340/Vaisala HMP45A (2)	Aug 2002	Sep 2017	0.5, 2.0	$^{\circ}\text{C}$	20 s (Aug 2002–Jul 2005), 15 s (Jul 2005–Jun 2009), 10 min (Jun 2009–Jul 2009), 10 s (Jul 2009–Jul 2010), 30 s (Jul 2010–Sep 2017)	avg 60 min (Aug 2002–Jun 2009), avg 30 min (Jun 2009–Jul 2009), avg 60 min (Jul 2009–Jul 2010), avg 30 min (Jul 2010–Sep 2017)	0.5 $^{\circ}\text{C}$ (-40 to 60 $^{\circ}\text{C}$)/ 0.5 $^{\circ}\text{C}$ (-40 to 60 $^{\circ}\text{C}$)/ 0.2 $^{\circ}\text{C}$ (20 $^{\circ}\text{C}$), linear increase: 0.5 $^{\circ}\text{C}$ (-40 $^{\circ}\text{C}$), 0.4 $^{\circ}\text{C}$ (60 $^{\circ}\text{C}$)
Air temperature (B)	Campbell Scientific PT100 (2)	Aug 2013	now	0.5, 2.0	$^{\circ}\text{C}$	30 s	avg 30 min	<0.15 $^{\circ}\text{C}$ (-100 $^{\circ}\text{C}$), <0.1 $^{\circ}\text{C}$ (0 $^{\circ}\text{C}$), <0.19 $^{\circ}\text{C}$ (100 $^{\circ}\text{C}$)
Relative humidity	Vaisala HMP155A (2)	Sep 2017	now	0.5, 2.0	%	30 s	avg 30 min	$(1.4 + 0.032 \times \text{RH})\%$ (-60 to -40 $^{\circ}\text{C}$), $(1.2 + 0.012 \times \text{RH})\%$ (-40 to -20 $^{\circ}\text{C}$), $(1.0 + 0.008 \times \text{RH})\%$ (-20 to 40 $^{\circ}\text{C}$)
Relative humidity	Rotronic MP103A/Rotronic MP340/Vaisala HMP45A (2)	Aug 2002	Sep 2017	0.5, 2.0	%	20 s (Aug 2002–Jul 2005), 15 s (Jul 2005–Jun 2009), 10 min (Jun 2009–Jul 2009), 10 s (Jul 2009–Jul 2010), 30 s (Jul 2010–Sep 2017)	avg 60 min (Aug 2002–Jun 2009), avg 30 min (Jun 2009–Jul 2009), avg 60 min (Jul 2009–Jul 2010), avg 30 min (Jul 2010–Sep 2017)	2% (0 to 90% , 20 $^{\circ}\text{C}$), 3% (90 to 100% , 20 $^{\circ}\text{C}$)

Variable	Sensor (number of sensors, if > 1)	Period of operation		Height (m)	Unit	Measuring interval	Integration method	Accuracy (\pm)	Spectral range
		from	to						
							2010–Sep 2017)		
Atmospheric pressure	Vaisala PTB110	Aug 2014	now	0.7	mbar	30 s	avg 30 min	1.5 mbar (–40 to +60 °C)	
Incoming & outgoing shortwave radiation	Kipp & Zonen CNR4 with CNF4	Aug 2014	now	1.95 (Aug 2014–Jul 2016), 2.08 (Jul 2016–now)	W m ⁻²	30 s	avg 30 min	<5% (daily total, 95% confidence level)	300–2800 nm (50% points)
Incoming & outgoing shortwave radiation	Hukseflux NR01	Jul 2010	Aug 2014	1.96	W m ⁻²	30 s	avg 30 min	10% (daily totals)	285–3000 nm
Incoming & outgoing shortwave radiation	Kipp & Zonen CNR1	Jun 2009	Jul 2010	2	W m ⁻²	10 s	avg 30 min	10% (daily totals)	305–2800 nm (50% points)
Incoming & outgoing longwave radiation	Kipp & Zonen CNR4 with CNF4	Aug 2014	now	1.95 (Aug 2014–Jul 2016), 2.08 (Jul 2016–now)	W m ⁻²	30 s	avg 30 min	<10% (daily totals, 95% confidence level)	4.5–42 μ m (50% points)
Incoming & outgoing longwave radiation	Hukseflux NR01	Jul 2010	Aug 2014	1.96	W m ⁻²	30 s	avg 30 min	10% (daily totals)	4.5–40 μ m
Incoming & outgoing longwave radiation	Kipp & Zonen CNR1	Jun 2009	Jul 2010	2	W m ⁻²	10 s	avg 30 min	10% (daily totals)	4.5–42 μ m
Outgoing longwave radiation	Kipp & Zonen CG1	Aug 2002	Jun 2009	1.28	W m ⁻²	20 s (Aug 2002–Jul 2005), 15 s (Jul 2005–Jun 2009)	avg 60 min	10% (daily totals)	4.5–42 μ m (50% points)
Net radiation	Kipp & Zonen NR LITE	Aug 2002	Jun 2009	1.35	W m ⁻²	20 s (Aug 2002–Jul 2005), 15 s (Jul 2005–Jun 2009)	avg 60 min	3–20%	0.2–100 μ m
Precipitation (liquid)	R. M. Young Company 52203	Jul 2010	now	0.35	mm	30 s	sum 30 min	2% (\leq 25 mm h ⁻¹)	
Precipitation (liquid)	Environmental Measurements ARG100	Aug 2002	Oct 2009	0.4	mm	20 s (Aug 2002–Jul 2005), 15 s (Jul 2005–Jun 2009), 10 s (Jun 2009–Oct 2009)	sum 60 min (Aug 2002–Jun 2009), sum 30 min (Jun 2009–Jul 2010)	0.2 mm tip-1 4% for rainfall rates of 25 mm h ⁻¹ 1.8% for 133 mm h ⁻¹	

Variable	Sensor (number of sensors, if > 1)	Period of operation		Height (m)	Unit	Measuring interval	Integration method	Accuracy (\pm)	Spectral range
		from	to						
Snow depth	Campbell Scientific SR50	Aug 2002	now	1.23 (Aug 2002–Jul 2015), 1.07 (Jul 2015–now)	m	60 min	spl 60 min	0.4% (of distance to snow surface)	
Wind direction	R. M. Young Company 05103	Aug 2002	now	3	$^{\circ}$	20 s (Aug 2002–Jul 2005), 15 s (Jul 2005–Jun 2009), 10 s (Jun 2009–Jul 2010), 30 s (Jul 2010–now)	avg 60 min (Aug 2002–Jun 2009), avg 30 min (Jun 2009–now)	3°	
Wind speed	R. M. Young Company 05103	Aug 2002	now	3	m s^{-1}	20 s (Aug 2002–Jul 2005), 15 s (Jul 2005–Jun 2009), 10 s (Jun 2009–Jul 2010), 30 s (Jul 2010–now)	avg 60 min (Aug 2002–Jun 2009), avg 30 min (Jun 2009–now)	0.3 m s^{-1}	
Time lapse photography	Campbell Scientific CC640	Sep 2006	now	2.2	px	1 day (at 12:00 local time/UTC+09)			
Time lapse photography	Campbell Scientific CC5MPX	Aug 2015	now	3	px	60 min (from 11:00 to 14:00 local time/UTC+09)			
Below-ground sensors									
Soil temperature	Campbell Scientific 107 (Aug 2002–Jul 2015: 32, Jul 2015–now: 33)	Aug 2002	now	-0.01 to -2.71	$^{\circ}\text{C}$	10 min	avg 60 min	<1.0 $^{\circ}\text{C}$ (-40 to +56 $^{\circ}\text{C}$), <0.5 $^{\circ}\text{C}$ (-38 to +52 $^{\circ}\text{C}$), <0.1 $^{\circ}\text{C}$ (-23 to +48 $^{\circ}\text{C}$)	
Soil/permafrost temperature	RBR Thermistor chain (24)	Aug 2006	now	0 to -26.75	$^{\circ}\text{C}$	60 min	spl 60 min	0.1 $^{\circ}\text{C}$	
Soil bulk electrical conductivity	Campbell Scientific TDR100 + CS605 (20)	Aug 2002	now	-0.05 to -0.70	S m^{-1}	60 min	spl 60 min		
Soil volumetric liquid water content	Campbell Scientific TDR100 + CS605 (20)	Aug 2002	now	-0.05 to -0.70	%	60 min	spl 60 min		
Ground heat flux	Hukseflux HFP01 (2)	Aug 2002	now	-0.05, -0.06	W m^{-2}	10 min	avg 60 min	-15% to +5% (12 h total)	
Water level	Campbell Scientific CS616	Jul 2010	now	-0.115	cm	30 s	avg 30 min	2.5% ($\leq 0.5 \text{ dS m}^{-1}$, bulk density $\leq 1.55 \text{ g cm}^{-3}$, 0% to 50% 0l)	
Water level	Campbell Scientific CS625	Jul 2007	Jul 2010	-0.15	cm	10 min (Jul 2007–Jul 2009),	avg 60 min (Jul 2007–Jul	2.5% ($\leq 0.5 \text{ dS m}^{-1}$, bulk	

Variable	Sensor (number of sensors, if > 1)	Period of operation from to	Height (m)	Unit	Measuring interval	Integration method	Accuracy (±)	Spectral range
					10 s (Jul 2009–Jul 2010)	2009), avg 30 min (8–12 Jul 2009), avg 60 min (Jul 2009–Jul 2010)	density ≤1.55 g cm ⁻³ , 0% to 50% θl)	

605 **Table 3.** Description of data level and quality control for data flags. Most data is flagged automatically, some are occasionally flagged manually (Flag 3: maintenance, Flag 6: plausibility). Online data transfer is not currently operational but is planned for the future.

Flag	Meaning	Description
ONL	Online data	Data from online stations, daily download, used for online status check
RAW	Raw data	Base data from offline stations, 3-monthly backup of online data, used for maintenance check in the field
LV0	Level 0	Standardized data format with <u>data in</u> equal time steps (UTC), <u>filled with NA for data with no gaps and in a standard data format</u>
LV1	Level 1	Quality-controlled data including flags; quality control includes maintenance periods, physical plausibility, spike/constant value detection, sensor drifts, and snow on sensor detection
LV2	Level 2	Modified data compiled for special purposes such as combined data series from multiple sensors and gap-filled data
0	Good data	All quality tests passed
1	No data	Missing value
2	System error	System failure led to corrupted data, e.g. due to power failure, sensors being removed from their proper location, broken or damaged sensors, or the data logger saving error codes
3	Maintenance	Values influenced by the installation, calibration, and cleaning of sensors or programming of the data logger; information from field protocols of engineers
4	Physical limits	Values outside the physically possible or likely limits
5	Gradient	Values unlikely because of prolonged constant periods or high/low spikes; test within each individual series
6	Plausibility	Values unlikely in comparison with other series or for a given time of the year; flagged manually by engineers
7	Decreased accuracy	Values with reduced sensor accuracy, e.g. identified if freezing soil does not show a temperature of 0 °C
8	Snow-covered	Good data, but the sensor is snow-covered

Appendix A: Symbols and abbreviations

α	geometry of the medium in relation to the orientation of the applied electrical field (Roth et al., 1990)
ε_b	bulk dielectric number (Ka), also referred to as relative permittivity
ε_l	temperature-dependent dielectric number of liquid water
ε_i	dielectric number of ice
ε_s	dielectric number of soil matrix
ε_a	dielectric number of air
θ_l	volumetric liquid water content
θ_i	volumetric ice content
θ_s	volumetric soil matrix fraction
θ_a	volumetric air fraction
θ_{tot}	total volumetric water content (liquid water and ice)
$\bar{\rho}_{bulk}$	average dry bulk density (kg m^{-3})
Φ	porosity (%)
avg	average
BEC	bulk electrical conductivity (S m^{-1})
CALM	Circumpolar Active Layer Monitoring
CAVM	Circumpolar Arctic Vegetation Map
CD_{bulk}	bulk carbon density (kg m^{-3})
ECV	essential climate variables
GNSS	global navigation satellite system
GTN-P	Global Terrestrial Network on Permafrost
K_p	probe constant
$\frac{L_a}{L}$	apparent length of the TDR probes (TDR data logger output)
MODIS	moderate resolution imaging spectroradiometer
N	mass fraction of nitrogen in soil (%)

OC	mass fraction of organic carbon in soil (%)
SOCC	soil organic carbon content (kg m^{-2})
SP	signal period (μms)
spl	sample
TDR	time-domain reflectometry
T_f	freezing temperature ($^{\circ}\text{C}$)
TLS	terrestrial laser scanning
USDA	United States Department of Agriculture
WL	water level (m)
ZAA	zero annual amplitude

610 **Appendix B: Metadata description and photos of meteorological, soil and permafrost stations and instrumentation**

B1 Meteorological station



615 **Figure B1.** Samoylov meteorological station setup, August 2002–present (72.37001° N, 126.48106° E). Photo taken in August 2015. The two long radiation shields (left side of tower) at heights of 0.5 m and 2 m house the combined temperature and relative humidity probes (two Vaisala HMP155A sensors were installed on 17 September 2017) and the two shorter shields (right side of tower) at the same heights contain Campbell Scientific PT100 sensors (installed
620 on 22 August 2013) to measure air temperature only. The data logger (Campbell Scientific CR1000, installed on 30 June 2009), multiplexer (Campbell Scientific AM16/32A, installed on 27 July 2010) and barometric pressure sensor (Vaisala PTP110, installed on 22 August 2014) are located in the white box at the back of the tower. The wind monitor and radiation sensor are shown in the figures below (Figures B2 and B3).



Figure B2. Young 05103 wind monitor for measuring wind direction and speed, installed on 31 August 2002.



Figure B3. Kipp & Zonen CNR4 radiation sensor (including CNF4 ventilation unit) for measuring incoming and outgoing shortwave and longwave radiation, respectively, installed on 22 August 2014.



Figure B4. Campbell Scientific SR50 snow depth sensor, installed on 24 August 2002. An aluminum plate was installed on the ground surface beneath the sensor beam on 17 July 2015.



Figure B5. Cameras for time lapse photography of snow cover and land surface pointing towards the polygon field: a Campbell Scientific CC5MPX at the top (since 4 August 2015) and a Campbell Scientific CC640 below (since 1 September 2006). Photo taken in 2016.

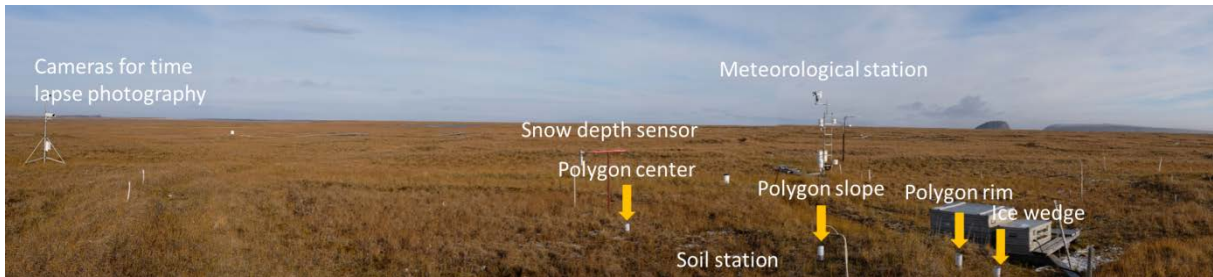

Figure B6. Examples of photos taken by the cameras used for time lapse photography (Figure B5) showing summer field conditions. Left photo taken by the Campbell Scientific CC640 camera (at a height of 2.2 m) and right photo taken by the Campbell Scientific CC5MPX camera (at a height of 3 m) on 7 August 2017.

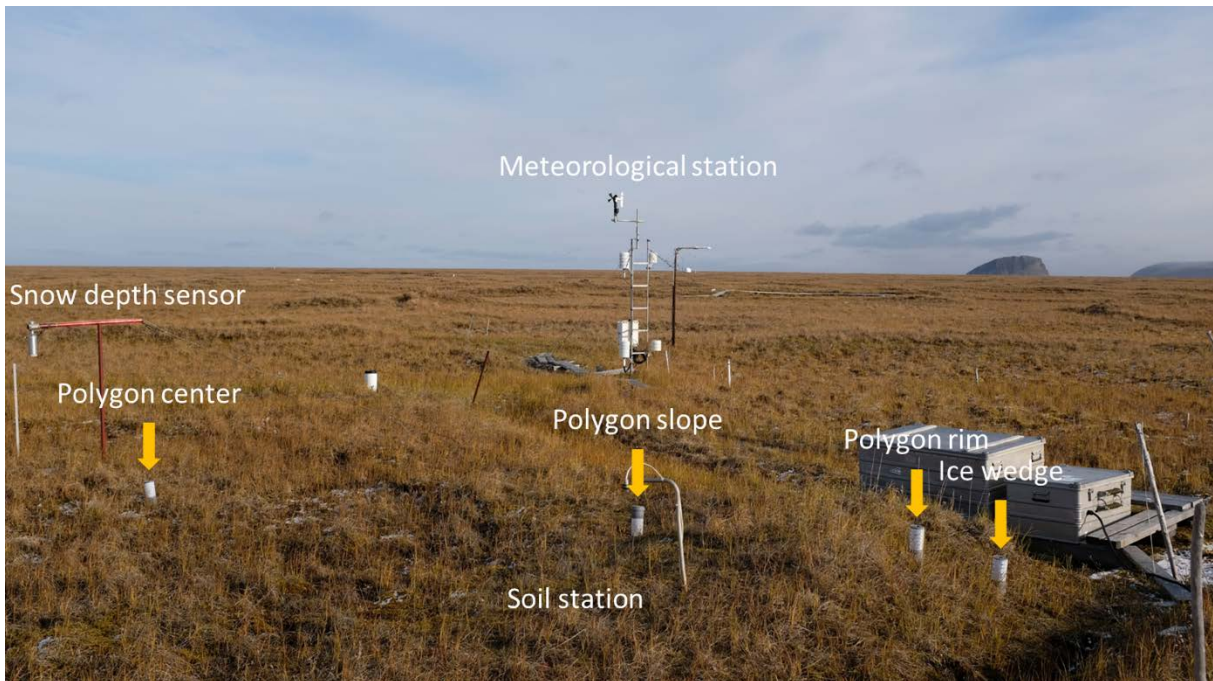

Figure B7. Examples of photos taken by cameras used for time lapse photography (Figure B5) showing winter field conditions. Left photo taken by the Campbell Scientific CC640 camera (at a height of 2.2 m) and right photo taken by the Campbell Scientific CC5MPX camera (at a height of 3 m) on 4 April 2017.

B2 Soil station



630 **Figure B8.** Meteorological station and soil station (consisting of sensors installed along 1D profiles within polygon center, rim, slope, and ice wedge) with cameras for time lapse photography pointing towards both stations for snow and surface observation.



635 **Figure B9.** Samoylov research site in September 2017, showing locations of meteorological station and soil station (consisting of sensors installed along 1D profiles within polygon center, rim, slope, and ice wedge). White/grey tubes have been placed on the surface to indicate the locations of the sub-surface sensors and their respective microtopographic locations (polygon center, rim, slope, and ice wedge).

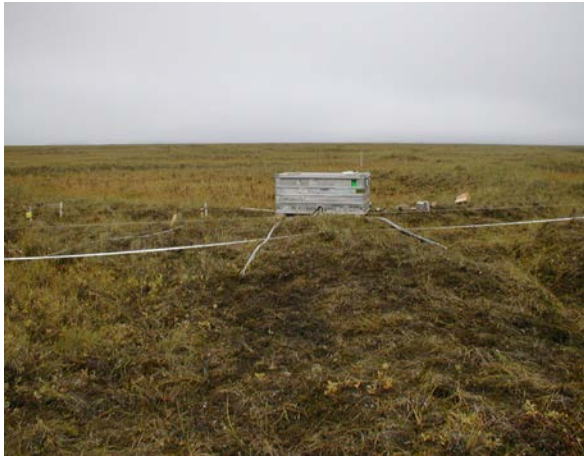

Figure B10. Research site after instrument installation in soil pits and subsequent refilling, August 2002. Cable strings indicate locations of center, slope, and rim profiles.

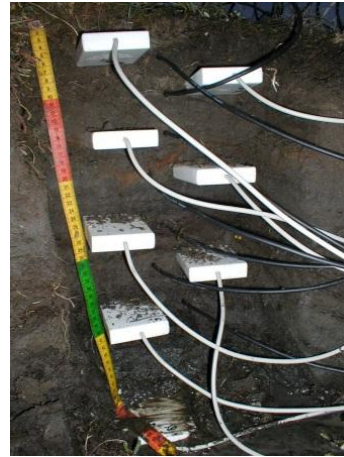

Figure B11. Soil volumetric liquid water content sensors ([rim](#)): 20 Campbell Scientific CS605 TDR probes, which are connected to a Campbell Scientific TDR100 time-domain reflectometer, installed on 24 August 2002.

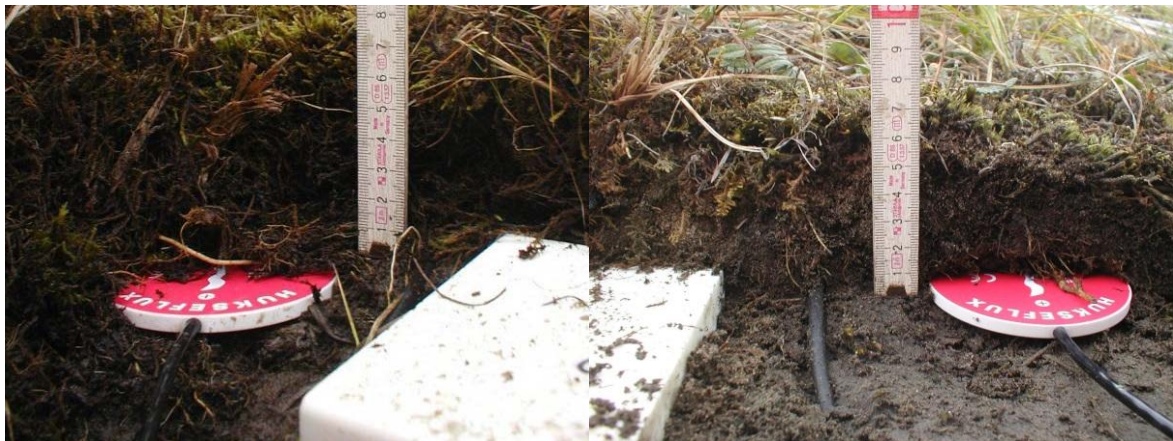

Figure B12. Hukseflux HFP01 ground heat-flux sensors ([left: center, right: rim](#)), installed on 24 August 2002.

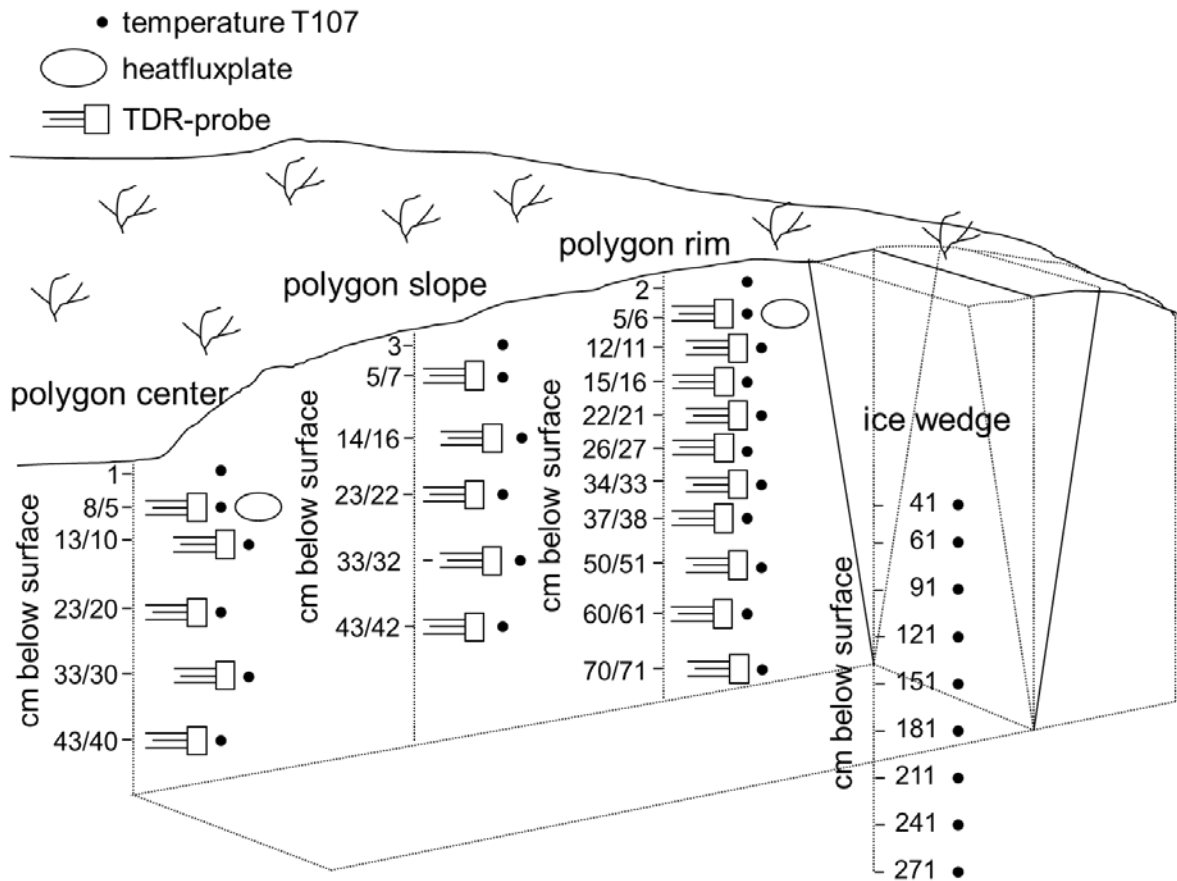

Figure B13. Diagram showing the sensor distribution below the polygon's center, slope and inside the ice wedge, as installed on 24 August 2002. Descriptions of soil profiles and data from these profiles are provided in Appendix F.

Appendix C: Calculation and correction of soil and meteorological parameters

640

C1 Calculation of soil volumetric liquid water content using TDR

The apparent dielectric numbers were converted into liquid water content (θ_l) using the semi-empirical mixing model in Roth et al. (1990). Frozen soil was treated as a four-phase porous medium composed of a solid (soil) matrix and interconnected pore spaces filled with water, ice, and air.

645

The TDR method measures the ratio of apparent to physical probe rod length ($\frac{L_a}{L}$) which is equal to the square root of the bulk dielectric number (ϵ_b).

The bulk dielectric number is then calculated from the volumetric fractions and the dielectric numbers of the four phases using

$$\epsilon_b = [\theta_l \epsilon_l^\alpha + \theta_i \epsilon_i^\alpha + \theta_s \epsilon_s^\alpha + \theta_a \epsilon_a^\alpha]^{\frac{1}{\alpha}} \quad (C1)$$

650 A value of 0.5 was used for α .

It is not possible to distinguish between changes in the liquid water content and changes in the ice content with only one measured parameter (ϵ_b). Equation C1 was therefore rewritten in terms of the total water content (θ_{tot}) and the porosity (Φ) as

$$\theta_i = \theta_{tot} - \theta_l \quad (C2)$$

Note that Equation C2 assumes the densities of liquid and frozen water to be the same, which is clearly incorrect for free phases and probably also in the pore space of soils. However, the density ratio can be absorbed into the dielectric number ϵ_i , which we do below. The resulting fluctuation of ϵ_i is presumed to be small compared to other uncertainties.

655

We use

$$\theta_s = 1 - \phi \quad (C3)$$

and

$$\theta_a = \phi - \theta_l - \theta_i = \phi - \theta_{tot} \quad (C4)$$

660 to obtain the equation

$$\varepsilon_b = [\theta_l \varepsilon_l^\alpha + (\theta_{tot} - \theta_l) \varepsilon_i^\alpha + (1 - \phi) \varepsilon_s^\alpha + (\phi - \theta_{tot}) \varepsilon_a^\alpha]^{\frac{1}{\alpha}} \quad (C5)$$

For temperatures above a threshold freezing temperature ($T > T_f$), all water is assumed to be unfrozen ($\theta_{tot} = \theta_l$). Equation C5 then reduces to:

$$\theta_l(T) = \frac{\varepsilon_b^\alpha - \varepsilon_s^\alpha + \phi(\varepsilon_s^\alpha - \varepsilon_a^\alpha)}{\varepsilon_l^\alpha - \varepsilon_a^\alpha} \quad \text{if } T > T_f \quad (C6)$$

For temperatures equal to or below the threshold freezing temperature ($T \leq T_f$) it was assumed

that the total water content (θ_{tot}) remained constant and only the ratio between volumetric liquid

665 water content (θ_l) and volumetric ice content (θ_i) changed. This is a rather bold assumption as freezing can lead to high gradients of matric potential, as well as to moisture redistribution.

However, since the dielectric number of ice is much smaller than the dielectric number of liquid water, the error in liquid water content measurements is still acceptable (which is not the case

for ice content measurements). Under these assumptions we obtained the following equation

670 for calculating the liquid water content of a four-phase mixture:

$$\theta_l(T \leq T_f) = \frac{\varepsilon_b^\alpha - \varepsilon_s^\alpha + \phi(\varepsilon_s^\alpha - \varepsilon_a^\alpha) + \theta_{tot}(\varepsilon_a^\alpha - \varepsilon_i^\alpha)}{\varepsilon_l^\alpha - \varepsilon_i^\alpha} \quad (C7)$$

The error of the volumetric water content measurements using TDR probes was estimated to be between 2 and 5%, which is in agreement with Boike and Roth (1997).

The availability of reliable temperature data is crucial in this approach. The liquid water content is first calculated for all times when the soil temperature was above the freezing threshold, using Equation C5. When the soil temperature was below the freezing threshold the water content immediately prior to the onset of freezing was determined and used as the total water content (θ_{tot}) for calculating the liquid water content during the frozen interval with Equation C7.

Since water in a porous medium does not necessarily freeze at 0 °C but at a temperature that depends on the soil type and water content, estimating the threshold temperature is a crucial part of this approach. If the freezing characteristic curve is known for the material then the threshold temperature can be determined from the soil volumetric liquid water content. To avoid interpretations of frequent freezing and thawing due to soil temperature measurement errors, short-term temperature fluctuations were smoothed by calculating the mean of a moving window with an adjustable width. The smoothed temperatures were then used to trigger the switch from one equation to the other, rather than using the original temperature time series.

The porosity values for volumetric liquid water content calculations were obtained from laboratory measurements (Appendix F) and adjusted for probe location, if necessary

Table C1. Porosity values for different depths and locations used for the calculation of volumetric liquid water content. Values were estimated using measured laboratory values, soil texture/horizon characteristics and TDR values at maximum saturation (=porosity).

Depth (cm)	Location		
	Center	Slope	Rim
5		93	67
8	98		
12			67
13	99		
14		93	
15			67
22			67

Depth (cm)	Location		
	Center	Slope	Rim
23	78	93	
26			73
33	99	100	
34			72
37			63
43	99	100	
50			60
60			55
70			64

C2 Snow depth correction for air temperature

The acoustic distance sensor (Campbell Scientific SR50) measures the elapsed time between emission and return of the ultrasonic pulse. The raw distance $D_{sn_{raw}}$ obtained from the sensor was temperature corrected using the speed of sound at 0 °C and the air temperature at 2 m height (Tair_200) in Kelvin (K), using the formula provided by the manufacturer (Campbell Scientific, 2007):

$$D_{sn} = D_{sn_{raw}} * \sqrt{\frac{T_{air_200} (K)}{273.15}} \quad (C8)$$

Appendix D: Metadata description and photos of installations for water level measurements

700

A measurement system was installed in a polygon center 3 m southeast of the meteorological station tower at 72.37001° N, 126.48106° E to allow changes in the water level to be recorded without requiring the presence of any personnel. A major disadvantage of using a common pressure transducer sensor to measure the water level is that such a device cannot withstand the long frozen arctic winter and is therefore not suitable for use when the presence of personnel is limited due to expedition schedules being restricted to summer period. A setup that can remain installed and withstand the cold winter temperatures therefore has a great advantage.

705

710

715

720

We apply vertically installed soil moisture probes to estimate water level, as described in Thomsen et al. (2000). Our sensors remained permanently in the soil with the circuit board at the base of the sensor and the parallel-connected rods pointing upwards. The base of the sensor marks the lowest measurable water level. For the water content reflectometer we measured the distance from the ground surface to the base of the sensor, where the measurement rods are connected (Figure D1), to compute water level below the ground surface. From 2007 to 2010 a Campbell Scientific CR200 data logger was connected to a Campbell Scientific CS625 probe (15 cm below the ground surface) to record the water level and two Campbell Scientific T109 sensors (1 cm and 6 cm below the surface) for temperature measurements. Since 2010 the setup has been connected to the main Campbell Scientific CR1000 logger of the meteorological station and the CS625 probe was therefore exchanged for a Campbell Scientific CS616 probe, installed 11.5 cm below the ground surface. Due to a change in data loggers in the summer of 2010, we have two setups with minor differences in the measurement probes and their

installation depths, which is detailed below and visualized in Figure D1. The difference between the two water content reflectometers is the electrical output voltage, which had to be changed in order to meet the requirements of the logger. A third T109 probe was also installed 3 cm below ground surface in 2010. This setup is still in operation. These temperature data are only used to distinguish between periods of frozen and unfrozen surface conditions. The unfrozen period, for which water levels were computed, was defined as the period for which soil temperatures at 6 cm below surface are $> 0.4^{\circ}\text{C}$ during spring, and $> 0.1^{\circ}\text{C}$ during fall. Below these temperatures, no water level data are provided, ~~frozen or freezing conditions are indicated with Flag 8 not included in the water level calculations (NA).~~ (snow covered; Table 3).

To obtain a better field calibration of the water content reflectometer a Schlumberger Mini-Diver pressure water level sensor was installed in a well in the same polygon for 68 days of the non-frozen vegetation period in 2016. Measurements obtained from the Diver were compensated for changes in air pressure using data from the meteorological station's barometric pressure sensor (Vaisala PTB110).

735

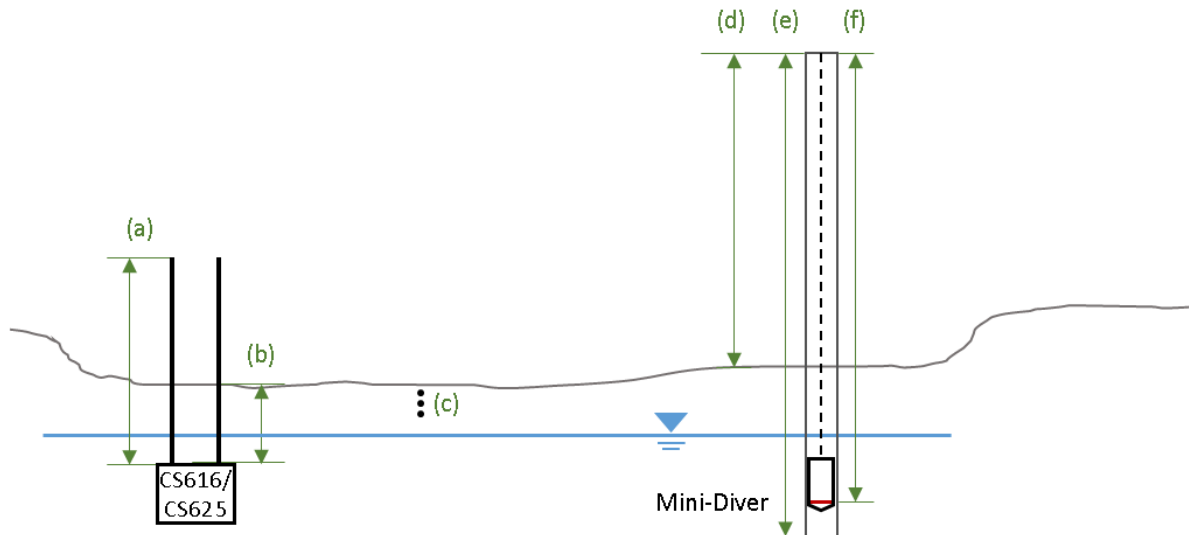

740

Figure D1. Scheme of setup of water level measurement in the polygon center: (a) length of the parallel measurement rods (30 cm) of the Campbell Scientific CS616/CS625 sensors, (b) distance from the sensor base to the ground surface (CS625: -15 cm; CS616 -11.5 cm), (c) Campbell Scientific T109 probes at depths of -1 cm, -3 cm, -6 cm below surface, (d) height of the well above the ground surface (45.5 cm), (e) length of the well (70 cm), (f) distance from the top of the well to the water pressure measurement level of the Schlumberger Mini-Diver. The difference between the ground level at CS616 and Mini-Diver locations is 3 cm. Blue line illustrates water level, green-gray line the ground surface.



Figure D2. Campbell Scientific CS616

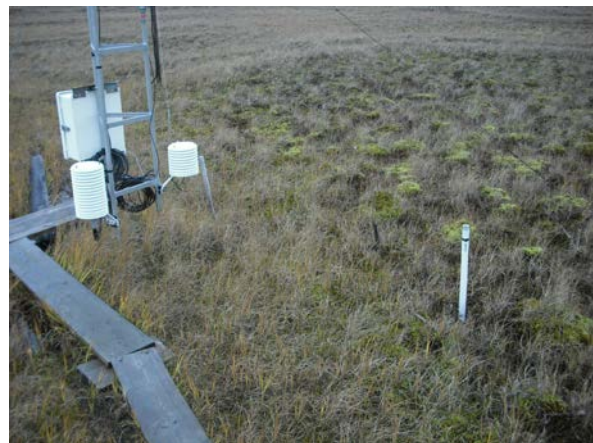

Figure D3. Installation for water level measurements using a permeable ground

vertical probe installation. Water level water measurement tube with a measurement is done manually with a ruler. Schlumberger Mini-Diver.

D1 Calculation and correction of water level measurements

745 The measured ~~output, signal~~ ~~output~~ period (SP) from the Campbell Scientific CS616 or CS625 probes were converted into the height of the water level above the sensor base (WL) using two polynomial functions derived from an empirical field experiment to determine the correlation between results from the CS616/CS625 probes and those from a Mini-Diver.

The two regressions represent different water level regimes (low and higher water levels) recorded by the CS616/CS625 sensor. The results of this experiment showed a low accuracy for very low water levels (1.5 cm or less above the sensor base) resulting in output periods of SP < 19 μ s, which were excluded from the data series. For values > 19 μ s, the following formulas are applied to obtain WL data from the CS616 and CS625 probe output:

$$WL = 0.01831394 SP^3 - 1.2398 SP^2 + 28.84699187 SP - 224.41499308 \quad (D1)$$

755 for SP < 27 ~~μ m- μ s~~ and

$$WL = 0.06194726 SP^2 - 1.7673294 SP + 13.66709591 \quad (D2)$$

for SP > 27 ~~μ m- μ s~~. [Note that WL for the equations above is is-given in cm.](#)

The mean deviation of the calculated WL values from the values measured with the Diver was (0.034 cm) with a standard deviation of 0.29 cm (number of values: 2679).

760 Note that WL is given relative to the ~~ground-sensor base surface~~ in the time series data and reported in meters. To obtain water level relative to the ground surface (WL_{gs}) from Level 1 data, the following calculation is suggested:

$$\text{for CS616} \quad \text{WL}_{\text{gs}} = \text{WL} - 0.115 \text{ m} \quad (\text{D3})$$

[\(from 27 July 2010 until now\)](#)

$$\text{for CS625} \quad \text{WL}_{\text{gs}} = \text{WL} - 0.15 \text{ m} \quad (\text{D4})$$

[\(from 25 July 2007 until 26 July 2010\)](#)

Special post-processing of the CS625 sensor readings was carried out from between 06 July
765 2009 to 26 July 2010, as no probe output periods were logged over this period. Instead, volumetric liquid water content (θ_l) was stored on the CR200 logger, calculated from the CS625 probe output and using a formula from the sensor's manual (Campbell Scientific, 2016). The θ_l values were converted to SP values using formula D5:

$$\text{SP} = 39.12153154 \theta_l^3 - 61.59657836 \theta_l^2 + 56.7054971 \theta_l + 15.37001712 \quad (\text{D5})$$

770 We compared the calculated WL with manual distance measurements taken in the field over the years ($n = 12$). The largest differences between TDR derived and manual measurements was 2 cm. This includes all measurement errors, such as sensor movement (probes are not anchored into the permafrost, they can potentially move with the seasonal heaving, subsiding of the active layer), difficulties in defining the ground surface (which is covered by mosses and
775 grasses).

Appendix E: Metadata description and photos of the borehole, 2006

A borehole was drilled at 72.36941° N, 126.47612° E into the permafrost during the spring of 2006. Drilling started with 146 mm diameter down to 4 m depth and continued with 132 mm diameter down to 26.75 m depth. A 4 m long metal stand pipe (diameter 13 cm) was used for stability and to prevent the inflow of water during summer season into the borehole. The metal pipe extends 0.5 m above and 3.5 m below the ground surface (Figures E1 and E2).



785 **Figure E1.** Location of the 2006 borehole showing the proximity of the borehole to a small lake. The metal pipe extends 0.5 m above the ground surface.

A thermistor chain with 24 temperature sensors (RBR thermistor chain with an XR-420 logger) was inserted into a close fitting PVC tube (4 cm inside, 5 cm outside diameter) and installed in the borehole on 21 August 2006, down to a depth of 26.75 m (Figure E2).

790 A second PVC tube with the same dimensions as the first tube was also inserted into the borehole to permit additional (geophysical and calibration) measurements to be made in the future. The remaining air space in the borehole was backfilled with dry sand. The outside metal pipe (used for drilling and to prevent inflow of water) which stands 0.5 m above ground surface, was closed at the top and was covered with a wooden shield, which was renewed in 2015.

795 The accuracy of the temperature sensors of the thermistor chain is reported by RBR to be ± 0.005 °C between -5 °C and 35 °C. However, direct comparison with a high precision reference PT100 temperature sensor (certified to be accurate to ± 0.01 °C between -20 and 30 °C) at six different depths in the borehole between 9 and 17 August 2014 showed the accuracy of the RBR XR-40 temperature sensors to be approximately ± 0.03 °C at depths ≥ 8.75 m (Table
800 E1). The deviation increased with decreasing depth, e.g. between -7.75 m and -1.75 m the deviation was ± 0.33 °C and at -0.75 m it was ± 0.65 °C. This increase in deviation towards the surface may be because (a) the chain was installed in sand whereas the calibration thermometer was in air and could therefore possibly have been affected by air circulation, or (b) the temperature gradient becomes steeper with decreasing depth height below the surface and thus
805 small differences between the measuring heights of the two sensors will have a larger impact on temperatures as the surface is approached. The offset of the reference thermometer at exactly 0 °C was 0.01 °C, and the average statistical accuracy ($U_{k=2}$) is given by the manufacturer as 0.1083 °C. During calibration in the borehole the temperature was given time to stabilize (i.e.

until the recorded temperature change was less than ± 0.03 °C) before being recorded (Table
810 E1).

Continuous measurements have been obtained since mid-August 2006 from sensor depths of
0.00, 0.75, 1.75, 2.75, 3.75, 4.75, 5.75, 6.75, 7.75, 8.75, 9.75, 10.75, 11.75, 12.75, 13.75, 14.75,
15.75, 16.75, 17.75, 18.75, 20.75, 22.75, 24.75, and 26.75 m below the ground surface. We
recommend that the temperature data from the three sensors at 0, 0.75, 1.75 and 2.75 m depths,
815 a should not be used due to the possibility of it having been affected by the metal access pipe.
The data from these sensors have not been flagged as they are of high quality, but they may not
provide an accurate reflection of the actual soil temperatures.

Construction of the new Russian Samoylov Island Research Station started in September 2011
and was completed in summer 2012. The new research station included a water supply from a
820 nearby lake. The water supply system (Figures E3 and E4) is an above-ground structure that is
likely to affect the wind and hence the accumulation of snow on the tundra surface. Visual
inspection in the vicinity of the borehole in April 2016 suggested an increased snow
accumulation around this location since construction of the water supply system. A new
borehole was drilled in April 2018 down to 61 m, far away from the research station and
825 associated structures. A new temperature chain ~~will be~~was installed in the ~~fall~~early summer of
2018 to provide deeper permafrost data, as well as observations from a second borehole.

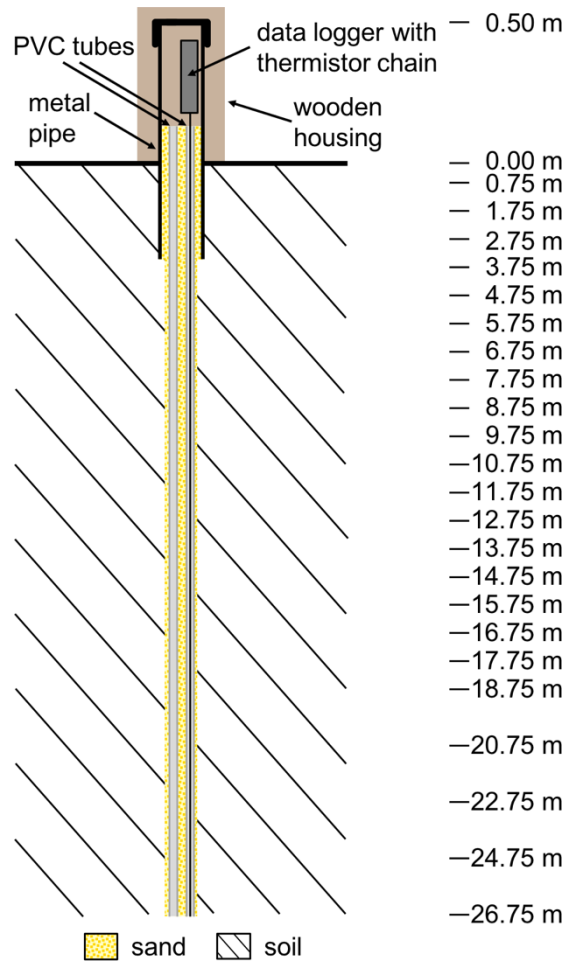

Figure E2. Thermistor setup showing their depths within the borehole, as installed in 2006.

The metal pipe extends 0.5 m above ground surface. Note the differences in scale between above and below ground surface.

830



Figure E3. Location of the 2006 borehole (wooden box) showing the proximity of the new water supply system (since 2013: silver metal structure extending above the tundra surface).



835 **Figure E4.** Borehole location (wooden box on right side) with the new Samoylov research station and water supply system (silver metal structure extending above the tundra surface).

Table E1. In situ calibration of thermometers in borehole between 9 and 17 August 2014. Comparison measurements were made in the 27 m borehole using a certified PT100 thermometer (Service für Messtechnik Geraberg DTM 3000).

Depth (m)	RBR Thermistor chain (°C)	DTM 3000 (°C)	Standard deviation <u>Difference</u> (°C)
0.00	8.88	8.78	0.10
-0.75	0.98	1.63	-0.65
-1.75	-1.95	-1.68	-0.27
-2.75	-3.52	-3.22	-0.30
-3.75	-4.79	-4.46	-0.33
-4.75	-5.75	-5.46	-0.29
-5.75	-6.46	-6.23	-0.23
-6.75	-6.91	-6.74	-0.17
-7.75	-7.15	-7.05	-0.10
-8.75	-7.30	-7.24	-0.06
-9.75	-7.37	-7.35	-0.03
-10.75	-7.43	-7.42	-0.01
-11.75	-7.50	-7.50	0.00
-12.75	-7.57	-7.57	0.00
-13.75	-7.64	-7.64	0.00
-14.75	-7.73	-7.74	0.00
-15.75	-7.82	-7.82	0.00
-16.75	-7.90	-7.89	-0.01
-17.75	-7.99	-7.98	-0.01
-18.75	-8.06	-8.06	0.00
-20.75	-8.20	-8.18	-0.02
-22.75	-8.30	-8.27	-0.03
-24.75	-8.35	-8.36	0.01
-26.75	-8.41	-8.41	0.00

Appendix F: Data from soil profiles

Table F1. Soil data from the BS-1 (polygon rim) and BS-3 (polygon center) soil pits, which were sampled and had instruments installed in 2002. The location of the soil profiles is described in Wille et al. (2003) and shown in Figure B8 and B9. Photos of the soil profiles can be seen in Figure F1 below. Grain size classification is according to Folk (1954) where S = sand, s = sandy, Z = silt, z = silty, M = mud, m = muddy, C = clay, and c = clayey. Other abbreviations used are OC for the mass fraction of organic carbon in soil, N for the mass fraction of nitrogen in soil, CD_{bulk} for the organic carbon density in bulk soil, and SOCC for the soil organic carbon content for each soil horizon. The soil horizon designations are according to the USDA's Soil Survey Staff (2010). The BS-1 and BS-2 soil profiles are classified as *Typic Aquiturbel* and the BS-3 soil profile is classified as *Typic Historthel* according to the US Soil Taxonomy (Soil Survey Staff, 2010). Analysis of the physical properties of soil was done according to DIN 19683 (1973). OC and N were determined following removal of inorganic carbon and dry combustion at 900 °C (DIN ISO 10694).

Sample ID	Date	Profile number	Horizon	Depth below surface (cm)	Horizon thickness (cm)	OC (%)	N (%)	Dry bulk density ($g\ cm^{-3}$)	Average dry bulk density ($g\ cm^{-3}$)	CD_{bulk} ($kg\ m^{-3}$)	SOCC ($kg\ m^{-2}$)	Φ (%)	Grain size class
LD02-6983	2002	BS-1	Oi	0	3	16.9	0.34		0.25	42	1.3	n.d.	organic
LD02-6984	2002	BS-1	Ajj1	3	4	3.1	0.17	0.96	0.96	29	1.2	64	zS
LD02-6985	2002	BS-1	Ajj2	7	8	1.8	0.11	1.25	1.25	22	1.8	52	zS
LD02-6986	2002	BS-1	Bjjg1	15	8	2.4	0.15	1.25	1.25	30	2.4	54	zS
LD02-6987	2002	BS-1	Bjjg2	23	6	5.6	0.31	0.88	0.88	49	2.9	68	sZ
LD02-6988	2002	BS-1	Bjjg3	29	5	3.3	0.17	0.95	0.95	31	1.5	65	S
LD02-6989	2002	BS-1	Bjjg4	34	6	5.5	0.27	0.86	0.86	48	2.9	67	sZ
LD02-6990	2002	BS-1	Bjjgf1	40	15	2.5	0.17		0.9	23	3.4	n.d.	sZ

Sample ID	Date	Profile number	Horizon	Depth below surface (cm)	Horizon thickness (cm)	OC (%)	N (%)	Dry bulk density (g cm ⁻³)	Average dry bulk density (g cm ⁻³)	CD _{bulk} (kg m ⁻³)	SOCC (kg m ⁻²)	Φ (%)	Grain size class
LD02-6991	2002	BS-1	Bjjgf2	55	10	1.7	0.13		0.9	15	1.5	n.d.	sZ
LD02-6992	2002	BS-1	Bjjgf3	65	35	1.4	0.11		0.9	13	4.5	n.d.	sZ
LD02-7007	2002	BS-3	Oi	0	15	19.5	0.62	0.1	0.1	20	2.9	99	organic
LD02-7008	2002	BS-3	A	15	19	5.1	0.14	0.65	0.65	33	6.3	78	S
LD02-7009	2002	BS-3	Bgf	34	16	5.2	0.22		0.9	46	7.4	n.d.	S

The organic carbon density in bulk soil CD_{bulk} (kg m⁻³) was calculated using the mass fraction of organic carbon in soil OC, the average dry bulk density $\bar{\rho}_{\text{bulk}}$, and the following formula:

$$CD_{\text{bulk}} = OC * \bar{\rho}_{\text{bulk}} \quad (\text{F1})$$

The organic carbon content for each soil horizon SOCC (kg m⁻²) was calculated using the mass fraction of organic carbon in soil OC, the average dry bulk density $\bar{\rho}_{\text{bulk}}$, the horizon thickness,

860 and the following formula:

$$SOCC = OC * \bar{\rho}_{\text{bulk}} * \text{horizon thickness} = CD_{\text{bulk}} * \text{horizon thickness} \quad (\text{F2})$$

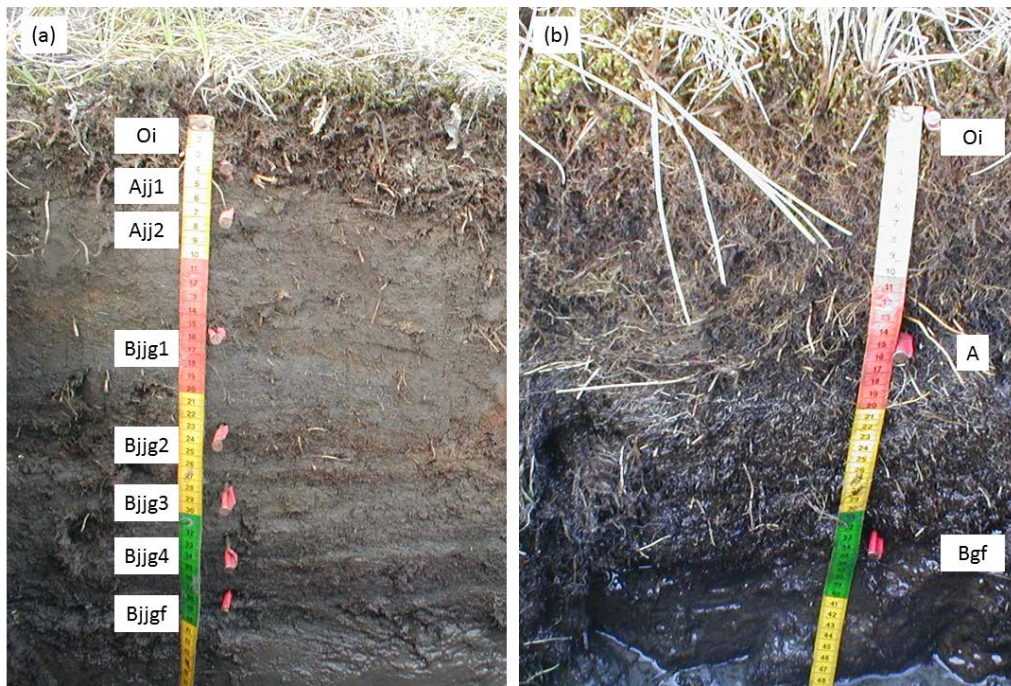

865 **Figure F1.** Photographs of soil profiles **(a)** BS-1 (*Typic Aquiturbel*) at the peak of a polygon rim and **(b)** BS-3 (*Typic Historthel*) at a polygon center. Designations of soil horizons according to US Soil Taxonomy (Soil Survey Staff, 2010). Horizon labels are positioned at the upper boundary of the respective horizon.

Appendix G: names of the variables and units for data files

870 **Table G1.** Overview of all variables published as time series. Some variables have `_center`, `_rim` and `_slope` as location index (Section 3.2). Additional Level 2 data is published for the variables air temperature, relative humidity, precipitation, wind speed and direction, net radiation, soil temperatures, and soil volumetric liquid water content, which is indicated by “`_lv2`” in the column name. If an air temperature sensor is covered by snow and thus measures snow temperature, this is indicated by a Flag 8 in the data.

Variable	Column name	Units
air/ _snow-covered air temperature	Tair_(height in cm)	°C
relative humidity	RH_(height in cm)	%
atmospheric pressure	PA	kPa
incoming shortwave radiation	SwIn	W m ⁻²
outgoing shortwave radiation	SwOut	W m ⁻²
incoming longwave radiation	LwIn	W m ⁻²
outgoing longwave radiation	LwOut	W m ⁻²
net radiation	RadNet	W m ⁻²
wind speed	Vwind_(height in cm)	m s ⁻¹
wind speed maximum	Vwind_max_(height in cm)	m s⁻¹
wind speed minimum	Vwind_min_(height in cm)	m s⁻¹
wind direction	Dirwind_(height in cm)	°
wind direction standard deviation	Dirwind_sd_(height in cm)	°
active layer thaw depth	Dal_(ID)	cm
soil/permafrost temperature	Ts_(depth in cm)	°C
soil bulk electrical conductivity	Cond_(depth in cm)	S m ⁻¹
soil dielectric number	E2_(depth in cm)	–
soil volumetric liquid water content	Vwc_(depth in cm)	–
ground heat flux	G_(depth in cm)	W m ⁻²
precipitation (liquid)	Prec	mm
snow depth	Dsn	m
water level	WL	m

875

Appendix H: Terrestrial laser scanning – analysis of 2017 data

3D point cloud data was acquired for several polygons around the meteorological, soil and CALM sites by terrestrial laser scanning (TLS) on 12 September 2017, using a RIEGL VZ-400 3D TLS instrument. According to the manufacturer's specifications the TLS instrument measures 3D coordinates with an accuracy of 5 mm and a precision of 3 mm (RIEGL LMS, 2017). We captured the full extent of the research site, which has dimensions of approximately 70×70 m, from ten scan positions with a horizontal and vertical point spacing of 3 mm at 10 m measurement range. The single point clouds were registered into a common coordinate system using five cylindrical reflectors placed around the research site during the TLS data acquisition so that they were visible from all scan positions. Mean residual distances per scan position between the cylindrical reflectors amounted to 1.6 cm, with a standard deviation of 0.8 cm.

The registered 3D point cloud data set was georeferenced using high-accuracy global positioning measurements recorded with a global navigation satellite system (GNSS). We obtained GNSS measurements in static phase observation mode with a Leica Viva GS10 as the base station receiver and a GS15 mobile rover unit (Leica Geosystems, 2012a, b). According to the manufacturer's specifications (Leica Geosystems, 2012a) this mode achieves a measurement accuracy of 3 mm horizontally and 3.5 mm vertically with respect to the local reference frame established by the base station. The scan positions were georeferenced and registered using the RiSCAN PRO software (version 2.1.1, RIEGL LMS, 2016).

The raw data set was filtered using a statistical outlier removal (SOR, Rusu and Cousins, 2011) to remove spatially isolated points as outliers from the point cloud, with the number of neighbors set to 10 and the standard deviation multiplier threshold to 1.0.

900 A digital terrain model (DTM) representing the ground surface elevation was derived from this pre-processed data set. To determine the ground surface elevation the 3D TLS points were first classified into ground and non-ground points. For this we used a minimum approach, classifying all points within a search radius of ~~2.5-0~~ cm that were at less than ~~0-05.0~~ cm vertical distance from the minimum point elevation as ground points. This vertical distance threshold is included to take into account position uncertainties of the TLS acquisition. The ground points
905 in the 3D TLS data set are subsequently rasterized into the final DTM (with a cell size of 5.0 cm) using a robust moving planes interpolation strategy (TU Wien, 2016).

For evaluation purposes the DTM was compared to 27 GNSS measurements of the ground surface that were obtained during the TLS data acquisition. The data sets were compared by taking the difference between GNSS-based elevation measurements and the corresponding
910 DTM pixel values. Statistical analysis of these differences in ground surface elevation yielded a mean difference of 3.7 cm, a median difference of 1.7 cm, and a standard deviation of 5.1 cm. Differences were mainly within the accuracy ranges of TLS point cloud registration and GNSS positioning. Larger positive differences (> 2.0 cm) indicated an overestimation of ground surface elevation in the TLS point cloud. Where dense, short vegetation is present an error is
915 introduced to the estimated ground surface elevation as the laser beam does not hit the ground surface at every local area in the site. This is to be expected, particularly for larger distances

from the scan positions as the incidence angle from the TLS instrument has a direct effect on the penetration depth of the laser beam (Marx et al., 2017).

Relative height above the ground surface was derived as vertical distance of TLS points to the
920 ground surface. The DTM was used to calculate the vertical distance to the ground surface for
every 3D point in the TLS point cloud. A raster of relative height values was generated using
the 99th percentile of the relative height attribute per raster cell, with a cell size of 5.0 cm.
Furthermore, a raster of mean relative heights above ground surface was generated that could
provide an estimate of the vegetation height and volume within each 5 cm raster cell. With
925 regard to the vegetation height values derived from the TLS data, it should be noted that the
heights could be underestimated when compared to actual field measurements, for which there
are two possible explanations. Firstly, overestimation of the ground surface elevation (where
the laser beam does not fully penetrate the vegetation) reduces the calculated relative
(vegetation) height. Secondly, the sampling of the laser scanning process with the given 3D
930 point spacing implies an uncertainty in the maximum height being recorded at every local
position. This applies in particular to grass covered surfaces, where individual blades are not
necessarily hit by the laser beam at their highest point. Both of these effects can result in reduced
vegetation heights in a TLS-based approach, compared e.g., to length measurements of
individual sedges in the field.

935 The modular program system OPALS (version 2.3.0, Pfeifer et al., 2014) was used for the point
cloud analyses of ground surface elevation and relative height above the ground surface.

Acknowledgements. Logistical support was provided by the Russian-German Samoylov Research Base (1998–2012) and the Russian Samoylov Island Research Station (2013–2017). Field support, including data collection, was provided by Konstanze Piel, Steffen Frey, Günter 940 Stooft, and Waldemar Schneider. We gratefully acknowledge the funding received from the Helmholtz Association’s ACROSS (Advanced Remote Sensing – Ground Truth Demo and Test Facilities) project.

References

- 945 Aalto, J., Karjalainen, O., Hjort, J., and Luoto, M.: Statistical Forecasting of Current and Future Circum-Arctic Ground Temperatures and Active Layer Thickness, *Geophys. Res. Lett.*, 45, 4889–4898, DOI:10.1029/2018GL078007, 2018.
- Abnizova, A., Siemens, J., Langer, M., and Boike, J.: Small ponds with major impact: The relevance of ponds and lakes in permafrost landscapes to carbon dioxide emissions, *Global Biogeochem. Cycles*, 26, DOI:10.1029/2011gb004237, 2012.
- 950 Abramova, E., Vishnyakova, I., Boike, J., Abramova, A., Solovyev, G., and Martynov, F.: Structure of freshwater zooplankton communities from tundra waterbodies in the Lena River Delta, Russian Arctic, with a discussion on new records of glacial relict copepods, *Polar Biol.*, 1–15, DOI:10.1007/s00300-017-2087-2, 2017.
- 955 Antonova, S., Sudhaus, H., Strozzi, T., Zwieback, S., Kääb, A., Heim, B., Langer, M., Bornemann, N., and Boike, J.: Thaw Subsidence of a Yedoma Landscape in Northern Siberia, Measured In Situ and Estimated from TerraSAR-X Interferometry, *Remote Sensing*, 10, 494, DOI:10.3390/rs10040494, 2018.
- 960 Beringer, J., Lynch, A. H., Chapin, F. S., Mack, M., and Bonan, G.: The Representation of Arctic Soils in the Land Surface Model: The Importance of Mosses, *Journal Climate*, 14, 3324–3335, DOI:10.1175/1520-0442(2001)014<3324:TROASI>2.0.CO;2, 2001.
- Biskaborn, B. K. et al.: Permafrost is warming at a global scale, *Nature Communications*, submitted, 2018.
- 965 Boike, J., Ippisch, O., Overduin, P. P., Hagedorn, B., and Roth, K.: Water, heat and solute dynamics of a mud boil, Spitsbergen, *Geomorphology*, 95, 61–73, DOI:10.1016/j.geomorph.2006.07.033, 2008a.
- 970 Boike, J., Juszak, I., Lange, S., Chadburn, S., Burke, E., Overduin, P. P., Roth, K., Ippisch, O., Bornemann, N., Stern, L., Gouttevin, I., Hauber, E., and Westermann, S.: A 20-year record (1998–2017) of permafrost, active layer and meteorological conditions at a high Arctic permafrost research site (Bayelva, Spitsbergen), *Earth Syst. Sci. Data*, 10, 355–390, DOI:10.5194/essd-10-355-2018, 2018.
- 975 Boike, J., Kattenstroth, B., Abramova, K., Bornemann, N., Chetverova, A., Fedorova, I., Fröb, K., Grigoriev, M., Grüber, M., Kutzbach, L., Langer, M., Minke, M., Muster, S., Piel, K., Pfeiffer, E. M., Stoof, G., Westermann, S., Wischniewski, K., Wille, C., and Hubberten, H. W.: Baseline characteristics of climate, permafrost and land cover from a new permafrost observatory in the Lena River Delta, Siberia (1998–2011), *Biogeosciences*, 10, 2105–2128, DOI:10.5194/bg-10-2105-2013, 2013.

- Boike, J. and Roth, K.: Time Domain Reflectometry as a Field Method for Measuring Water Content and Soil Water Electrical Conductivity at a Continuous Permafrost Site, *Permafr. Periglac. Proc.*, 8, 359–370, DOI:10.1002/(SICI)1099-1530(199710/12)8:4<359::AID-PPP261>3.0.CO;2-S, 1997.
- Boike, J., Wille, C. , and Abnizova, A.: Climatology and summer energy and water balance of polygonal tundra in the Lena River Delta, Siberia, *J. Geophys. Res.*, 113, DOI:10.1029/2007JG000540, 2008b.
- [Burke, E. J., Chadburn, S., Krinner, G., Porada, P., Bartsch, A., Beer, C., Belelli Marchesini, L., Boike, J., Ekici, A., Elberling, B., Friborg, T., Hugelius, G., Johansson, M., Kuhry, P., Kutzbach, L., Langer, M., Lund, M., Parmentier, F.-J. W., Peng, S., van Huissteden, J. \(K.\), Wang, T., Westermann, S., and Zhu, D: Meteorological forcing data to run land surface models for five high latitude sites. Derived from reanalysis products combined with site observations, PANGAEA, <https://doi.pangaea.de/10.1594/PANGAEA.896133> \(DOI registration in progress\), 2018.](https://doi.pangaea.de/10.1594/PANGAEA.896133)
- Brown, J., Ferrians Jr, O. J., Heginbottom, J., and Melnikov, E.: Circum-Arctic map of permafrost and ground-ice conditions, National Snow and Ice Data Center/World Data Center for Glaciology, Boulder, CO, 1998.
- Campbell Scientific, Inc.: CS616 and CS625 Water Content Reflectometer – Instruction Manual, available at: <https://s.campbellsci.com/documents/us/manuals/cs616.pdf>, last access: 3 May 2018, 2016.
- Campbell Scientific, Inc.: SR50 Sonic Ranging Sensor – Instruction Manual, available at: <https://s.campbellsci.com/documents/us/manuals/sr50.pdf>, last access: 3 May 2018, 2007.
- Campbell Scientific, Inc.: TDR100 Time Domain Reflectometry Systems – Instruction Manual, available at: <https://s.campbellsci.com/documents/eu/manuals/tdr100.pdf>, last access: 3 May 2018, 2015.
- CAVM-Team: Circumpolar Arctic Vegetation Map. (1:7,500,000 scale), U.S. Fish and Wildlife Service, Anchorage, USA, 2005.
- Chadburn, S., Burke, E., Essery, R., Boike, J., Langer, M., Heikenfeld, M., Cox, P., and Friedlingstein, P.: An improved representation of physical permafrost dynamics in the JULES land-surface model, *Geosci. Model Dev.*, 8, 1493, DOI:10.5194/gmd-8-1493-2015, 2015.
- Chadburn, S. E., Krinner, G., Porada, P., Bartsch, A., Beer, C., Belelli Marchesini, L., Boike, J., Ekici, A., Elberling, B., Friborg, T., Hugelius, G., Johansson, M., Kuhry, P., Kutzbach, L., Langer, M., Lund, M., Parmentier, F. J. W., Peng, S., Van Huissteden, K., Wang, T., Westermann, S., Zhu, D., and Burke, E. J.: Carbon stocks and fluxes in the high latitudes: using

- site-level data to evaluate Earth system models, *Biogeosciences*, 14, 5143–5169, DOI:10.5194/bg-14-5143-2017, 2017.
- 1015 Cresto Aleina, F., Brovkin, V., Muster, S., Boike, J., Kutzbach, L., Sachs, T., and Zuyev, S.: A stochastic model for the polygonal tundra based on Poisson-Voronoi diagrams, *Earth System Dynamics*, 4, 12, DOI:10.5194/esd-4-187-2013, 2013.
- Dettmann, U., Bechtold, M., Frahm, E., and Tiemeyer, B.: On the applicability of unimodal and bimodal van Genuchten–Mualem based models to peat and other organic soils under evaporation conditions, *J. Hydrol.*, 515, 103–115, DOI:10.1016/j.jhydrol.2014.04.047, 2014.
- 1020 Ekici, A., Beer, C., Hagemann, S., Boike, J., Langer, M., and Hauck, C.: Simulating high-latitude permafrost regions by the JSBACH terrestrial ecosystem model, *Geosci. Model Dev.*, 7, 631–647, DOI:10.5194/gmd-7-631-2014, 2014.
- Ekici, A., Chadburn, S., Chaudhary, N., Hajdu, L. H., Marmy, A., Peng, S., Boike, J., Burke, E., Friend, A. D., Hauck, C., Krinner, G., Langer, M., Miller, P. A., and Beer, C.: Site-level model intercomparison of high latitude and high altitude soil thermal dynamics in tundra and barren landscapes, *The Cryosphere*, 9, 1343–1361, DOI:10.5194/tc-9-1343-2015, 2015.
- 1025 Fedorova, I., Chetverova, A., Bolshiyarov, D., Makarov, A., Boike, J., Heim, B., Morgenstern, A., Overduin, P. P., Wegner, C., Kashina, V., Eulenburg, A., Dobrotina, E., and Sidorina, I.: Lena Delta hydrology and geochemistry: long-term hydrological data and recent field observations, *Biogeosciences*, 12, 345–363, DOI:10.5194/bg-12-345-2015, 2015.
- 1030 Folk, R. L.: The distinction between grain size and mineral composition in sedimentary-rock nomenclature, *The Journal of Geology*, 62, 344–359, 1954.
- ~~Gouttevin, I., Langer, M., Löwe, H., Boike, J., Proksch, M., and Schneebeli, M.: Observation and modelling of snow at a polygonal tundra permafrost site: spatial variability and thermal implications (in review), *The Cryosphere Discuss.*, 2018, 1–43, DOI:10.5194/tc-2017-280, 2018.~~
- 1035 ~~Gouttevin, I., Langer, M., Löwe, H., Boike, J., Proksch, M., and Schneebeli, M.: Observation and modelling of snow at a polygonal tundra permafrost site: spatial variability and thermal implications, *The Cryosphere*, 12, 3693–3717, <https://doi.org/10.5194/tc-12-3693-2018>, 2018.~~
- 1040 Grigoriev, N. F.: The temperature of permafrost in the Lena delta basin–deposit conditions and properties of the permafrost in Yakutia, *Yakutsk*, 2, 97–101, 1960.
- Heimovaara, T. J. and de Water, E.: A Computer Controlled TDR System for Measuring Water Content and Bulk Electrical Conductivity. Laboratory of Physical Geography and Soil Science, University of Amsterdam, Amsterdam, 1993.
- 1045 Helbig, M., Boike, J., Langer, M., Schreiber, P., Runkle, B. R. K., and Kutzbach, L.: Spatial and seasonal variability of polygonal tundra water balance: Lena River Delta, northern Siberia (Russia), *Hydrogeology Journal*, 21, 133–147, DOI:10.1007/s10040-012-0933-4, 2013.

- 1050 Hukseflux: HFP01 & HFP03 Heat flux plate/heat flux sensor – User Manual, available at: https://www.hukseflux.com/sites/default/files/product_manual/HFP01_HFP03_manual_v1721.pdf, last access: 3 May 2018, 2016.
- Kneier, F., Overduin, P. P., Langer, M., Boike, J., and Grigoriev, M. N.: Borehole temperature reconstructions reveal differences in past surface temperature trends for the permafrost in the Laptev Sea region, Russian Arctic, *arktos*, 4, 7, DOI:10.1007/s41063-018-0041-3, 2018.
- 1055 Knoblauch, C., Beer, C., Liebner, S., Grigoriev, M. N., and Pfeiffer, E.-M.: Methane production as key to the greenhouse gas budget of thawing permafrost, *Nat. Clim. Change*, 8, 309, DOI:10.1038/s41558-018-0095-z, 2018.
- 1060 Knoblauch, C., Spott, O., Evgrafova, S., Kutzbach, L., and Pfeiffer, E.-M.: Regulation of methane production, oxidation, and emission by vascular plants and bryophytes in ponds of the northeast Siberian polygonal tundra, *J. Geophys. Res.-Biogeo.*, 120, 2525–2541, DOI:10.1002/2015JG003053, 2015.
- Koven, C. D., Riley, W. J., and Stern, A.: Analysis of permafrost thermal dynamics and response to climate change in the CMIP5 Earth System Models, *J. Climate*, 26, 1877–1900, DOI:10.1175/JCLI-D-12-00228.1, 2012.
- 1065 Kutzbach, L.: The Exchange of Energy, Water and Carbon Dioxide between Wet Arctic Tundra and the Atmosphere at the Lena River Delta, Northern Siberia, Alfred Wegener Institute, Bremerhaven, Germany, 2006.
- 1070 Kutzbach, L., Wagner, D., and Pfeiffer, E. M.: Effect of microrelief and vegetation on methane emission from wet polygonal tundra, Lena Delta, Northern Siberia, *Biogeochemistry*, 69, 341–362, DOI:10.1023/B: BIOG.0000031053.81520.db, 2004.
- Kutzbach, L., Wille, C., and Pfeiffer, E. M.: The exchange of carbon dioxide between wet arctic tundra and the atmosphere at the Lena River Delta, Northern Siberia, *Biogeosciences*, 4, 869–890, DOI:10.5194/bg-4-869-2007, 2007.
- 1075 Langer, M., Westermann, S., Boike, J., Kirillin, G., Grosse, G., Peng, S., and Krinner, G.: Rapid degradation of permafrost underneath waterbodies in tundra landscapes—Toward a representation of thermokarst in land surface models, *J. Geophys. Res.-Earth*, 2446–2470, DOI:10.1002/2016JF003956, 2016.
- 1080 Langer, M., Westermann, S., Heikenfeld, M., Dorn, W., and Boike, J.: Satellite-based modeling of permafrost temperatures in a tundra lowland landscape, *Remote Sens. Environ.*, 135, 12–24, DOI:10.1016/j.rse.2013.03.011, 2013.
- Langer, M., Westermann, S., Muster, S., Piel, K., and Boike, J.: The surface energy balance of a polygonal tundra site in northern Siberia - Part 1: Spring to fall, *The Cryosphere*, 5, 151–171, DOI:10.5194/tc-5-151-2011, 2011a.

- 1085 Langer, M., Westermann, S., Muster, S., Piel, K., and Boike, J.: The surface energy balance of a polygonal tundra site in northern Siberia - Part 2: Winter, *The Cryosphere*, 5, 509–524, DOI:10.5194/tc-5-509-2011, 2011b.
- 1090 Langer, M., Westermann, S., Walter Anthony, K., Wischniewski, K., and Boike, J.: Frozen ponds: production and storage of methane during the Arctic winter in a lowland tundra landscape in northern Siberia, Lena River Delta, *Biogeosciences*, 12, 977–990, DOI:10.5194/bg-12-977-2015, 2015.
- Leica Geosystems: Leica Viva GNSS GS10 receiver: Datasheet, available at: http://www.leica-geosystems.us/downloads123/zz/gpsgis/Viva%20GNSS/brochures-datasheet/Leica_Viva_GNSS_GS10_receiver_DS_en.pdf, last access: 3 May 2018, 2012a.
- 1095 Leica Geosystems: Leica Viva GNSS GS15 receiver: Datasheet, available at: http://w3.leica-geosystems.com/downloads123/zz/gpsgis/Viva%20GNSS/brochures-datasheet/Leica_Viva_GNSS_GS15_receiver_DS_en.pdf, last access: 3 May 2018, 2012b.
- 1100 Liljedahl, A. K., Boike, J., Daanen, R. P., Fedorov, A. N., Frost, G. V., Grosse, G., Hinzman, L. D., Iijma, Y., Jorgenson, J. C., Matveyeva, N.V., Necsoiu, M., Reynolds, M. K., Romanovsky, V. E., Schulla, J., Tape, K. D., Walker, D. A., Wilson, C. J., Yabuki, H., and Zona, D.: Pan-Arctic ice-wedge degradation in warming permafrost and its influence on tundra hydrology, *Nat. Geosci.*, 9, 312–318, DOI:10.1038/ngeo2674, 2016.
- 1105 Marx, S., Anders, K., Antonova, S., Beck, I., Boike, J., Marsh, P., Langer, M., and Höfle, B.: Terrestrial laser scanning for quantifying small-scale vertical movements of the ground surface in Arctic permafrost regions, *Earth Surf. Dynam. Discuss.*, 2017, 1–31, DOI:10.5194/esurf-2017-49, 2017.
- 1110 McGuire, A. D., Lawrence, D. M., Koven, C., Klein, J. S., Burke, E., Chen, G., Jafarov, E., MacDougall, A. H., Marchenko, S., Nicolsky, D., Peng, S., Rinke, A., Ciais, P., Gouttevin, I., Hayes, D. J., Ji, D., Krinner, G., Moore, J. C., Romanovsky, V., Schädel, C., Schaefer, K., Schuur, E. A. G., and Zhuang, Q.: Dependence of the evolution of carbon dynamics in the northern permafrost region on the trajectory of climate change, *Proceedings of the National Academy of Sciences*, 115, 3882–3887, DOI:10.1073/pnas.1719903115, 2018.
- Muster, S.: Decomposing Arctic Land Cover. Implications of heterogeneity and scale for the estimation of energy fluxes in Arctic tundra landscapes, PhD dissertation, Universität Heidelberg, 121 pp., 2013.
- 1115 Muster, S., Heim, B., Abnizova, A., and Boike, J.: Water body distributions across scales: A remote sensing based comparison of three Arctic tundra wetlands, *Remote Sensing*, 5, 1498–1523, DOI:10.3390/rs5041498, 2013.
- 1120 Muster, S., Langer, M., Heim, B., Westermann, S., and Boike, J.: Subpixel heterogeneity of ice-wedge polygonal tundra: a multi-scale analysis of land cover and evapotranspiration in the Lena River Delta, Siberia, *Tellus B*, 64, DOI:10.3402/tellusb.v64i0.17301, 2012.

[Nitzbon, J., Langer, M., Westermann, S., Martin, L., Aas, K. S., and Boike, J.: Pathways of ice-wedge degradation in polygonal tundra under different hydrological conditions, The Cryosphere Discuss., <https://doi.org/10.5194/tc-2018-211>, in review, 2018.](https://doi.org/10.5194/tc-2018-211)

1125 Pfeifer, N., Mandlbürger, G., Otepka, J., and Karel, W.: OPALS—A framework for Airborne Laser Scanning data analysis, *Computers, Environment and Urban Systems*, 45, 125–136, DOI:10.1016/j.compenvurbsys.2013.11.002, 2014.

RIEGL LMS: Laser Measurement Systems: Datasheet RIEGL VZ-400, available at: http://www.riegl.com/uploads/tx_pxriegl/downloads/10_DataSheet_VZ-400_2017-06-14.pdf, last access: 3 May 2018, 2017.

RIEGL LMS: Operating & Processing Software: RiSCAN PRO for RIEGL 3D Laser Scanners, available at: http://www.riegl.com/uploads/tx_pxriegl/downloads/11_DataSheet_RiSCAN-PRO_2016-09-19_01.pdf, last access: 3 May 2018, 2016.

1135 Romanovsky, V. E., Drozdov, D. S., Oberman, N. G., Malkova, G. V., Kholodov, A. L., Marchenko, S. S., Moskalenko, N. G., Sergeev, D. O., Ukraintseva, N. G., and Abramov, A. A.: Thermal state of permafrost in Russia, *Permafr. Periglac. Proc.*, 21, 136–155, DOI:10.1002/ppp.683, 2010.

1140 Roth, K., Schulin, R., Flüher, H., and Attinger, W.: Calibration of Time Domain Reflectometry for Water Content Measurement Using a Composite Dielectric Approach, *Water Resour. Res.*, 26, 2267–2273, DOI:10.1029/WR026i010p02267, 1990.

Runkle, B. R. K., Sachs, T., Wille, C., Pfeiffer, E.-M., and Kutzbach, L.: Bulk partitioning the growing season net ecosystem exchange of CO₂ in Siberian tundra reveals the seasonality of its carbon sequestration strength, *Biogeosciences*, 10, 1337–1349, DOI:10.5194/bg-10-1337-2013, 2013.

1145 Rusu, R. B. and Cousins, S.: 3D is here: Point Cloud Library (PCL), *Robotics and Automation (ICRA)*, 2011 IEEE International Conference on Robotics and Automation, Shanghai, China, 1–4, 2011.

1150 Sachs, T., Giebels, M., Boike, J., and Kutzbach, L.: Environmental controls on CH₄ emission from polygonal tundra on the microsite scale in the Lena river delta, Siberia, *Global Change Biology*, 16, 3096–3110, DOI:10.1111/j.1365-2486.2010.02232.x, 2010.

Sachs, T., Wille, C., Boike, J., and Kutzbach, L.: Environmental controls on ecosystem-scale CH₄ emission from polygonal tundra in the Lena River Delta, Siberia, *J. Geophys. Res.*, 113, DOI:10.1029/2007JG000505, 2008.

1155 Shiklomanov, N. I., Streletskiy, D. A., and Nelson, F. E.: Northern hemisphere component of the global circumpolar active layer monitoring (CALM) program, in: *Proceedings of the 10th International Conference on Permafrost*, Salekhard, Russia, 25–29 June 2012, 377–382, 2012.

- Soil Survey Staff: Keys to soil taxonomy, USDA – The National Resources Conservation Service, Lincoln, Nebraska, USA, 2010.
- 1160 Spott, O.: Frostmusterbedingte Seen der Polygonalen Tundra und ihre Funktion als Quellen atmosphärischen Methans, Diploma Thesis, Institut für Geographie, Universität Leipzig, 137 pp., 2003.
- Thomsen, A., Hansen, B., and Schelde, K.: Application of TDR to Water Level Measurement, *J. Hydrol.*, 236, 252–258, DOI:10.1016/S0022-1694(00)00305-X, 2000.
- 1165 TU Wien: Orientation and Processing of Airborne Laser Scanning Data (OPALS): Module Grid, available at: <http://geo.tuwien.ac.at/opals/html/ModuleGrid.html>, last access: 22 June 2018, 2016.
- 1170 Westermann, S., Langer, M., Boike, J., Heikenfeld, M., Peter, M., Etzelmüller, B., and Krinner, G.: Simulating the thermal regime and thaw processes of ice-rich permafrost ground with the land-surface model CryoGrid 3, *Geosci. Model Dev.*, 9, 1–24, DOI:10.5194/gmd-9-1-2016, 2016.
- Westermann, S., Peter, M., Langer, M., Schwamborn, G., Schirrmeister, L., Etzelmüller, B., and Boike, J.: Transient modeling of the ground thermal conditions using satellite data in the Lena River delta, Siberia, *The Cryosphere*, 11, 1441–1463, DOI:10.5194/tc-11-1441-2017, 2017.
- 1175 Wille, C., Kobabe, S., and Kutzbach, L.: Energy and water budget of permafrost soils – long time soil survey station on Samoylov Island, in: *Berichte zur Polar- und Meeresforschung 466/2003: Russian-German Cooperation SYSTEM LAPTEV SEA: The Expedition Lena-Anabar 2002*, Grigoriev, M. N., Rachold, V., Boshyanov, D. Y., Pfeiffer, E.-M., Schirrmeister, L., Wagner, D., and Hubberten, H.-W. (Eds.), Alfred-Wegener-Institut, Helmholtz-Zentrum für Polar-und Meeresforschung, 2003.
- 1180 Wille, C., Kutzbach, L., Sachs, T., Wagner, D., and Pfeiffer, E.-M.: Methane emission from Siberian arctic polygonal tundra: eddy covariance measurements and modeling, *Global Change Biology*, 14, 1395–1408, DOI:10.1111/j.1365-2486.2008.01586.x, 2008.
- 1185 Wille, Christian, Stoof, Günther, and Boike, Julia: Energy and water budget of permafrost soils – long time meteorology and soil survey station on Samoylov Island, in: *Berichte zur Polar- und Meeresforschung 466/2003: Russian-German Cooperation SYSTEM LAPTEV SEA: The Expedition Lena-Anabar 2003*, Schirrmeister, L., Grigoriev, M. N., Kutzbach, L., Wagner, D., and Bolshyanov, D. Y. (Eds.), Alfred-Wegener-Institut, Helmholtz-Zentrum für Polar-und Meeresforschung, 2004.
- 1190 Yang, X. and You, X.: Estimating parameters of van Genuchten model for soil water retention curve by intelligent algorithms, *Applied Mathematics & Information Sciences*, 7, 1977–1983, DOI:10.12785/amis/070537, 2013.

- 1195 Yi, S., Wischnewski, K., Langer, M., Muster, S., and Boike, J.: Freeze/thaw processes in complex permafrost landscapes of northern Siberia simulated using the TEM ecosystem model: impact of thermokarst ponds and lakes, *Geosci. Model Dev.*, 7, 1671–1689, DOI:10.5194/gmd-7-1671-2014, 2014.
- Zhang, T., Heginbottom, J. A., Barry, R. G., and Brown, J.: Further Statistics on the Distribution of Permafrost and Ground Ice in the Northern Hemisphere, *Polar Geography*, 24, 14–19, DOI:10.1080/10889370009377692, 2000.
- 1200 Zubrzycki, S., Kutzbach, L., Grosse, G., Desyatkin, A., and Pfeiffer, E. M.: Organic carbon and total nitrogen stocks in soils of the Lena River Delta, *Biogeosciences*, 10, 3507–3524, DOI:10.5194/bg-10-3507-2013, 2013.